

# BARCO

BARCO Projection Systems

SECTION T

service sheet

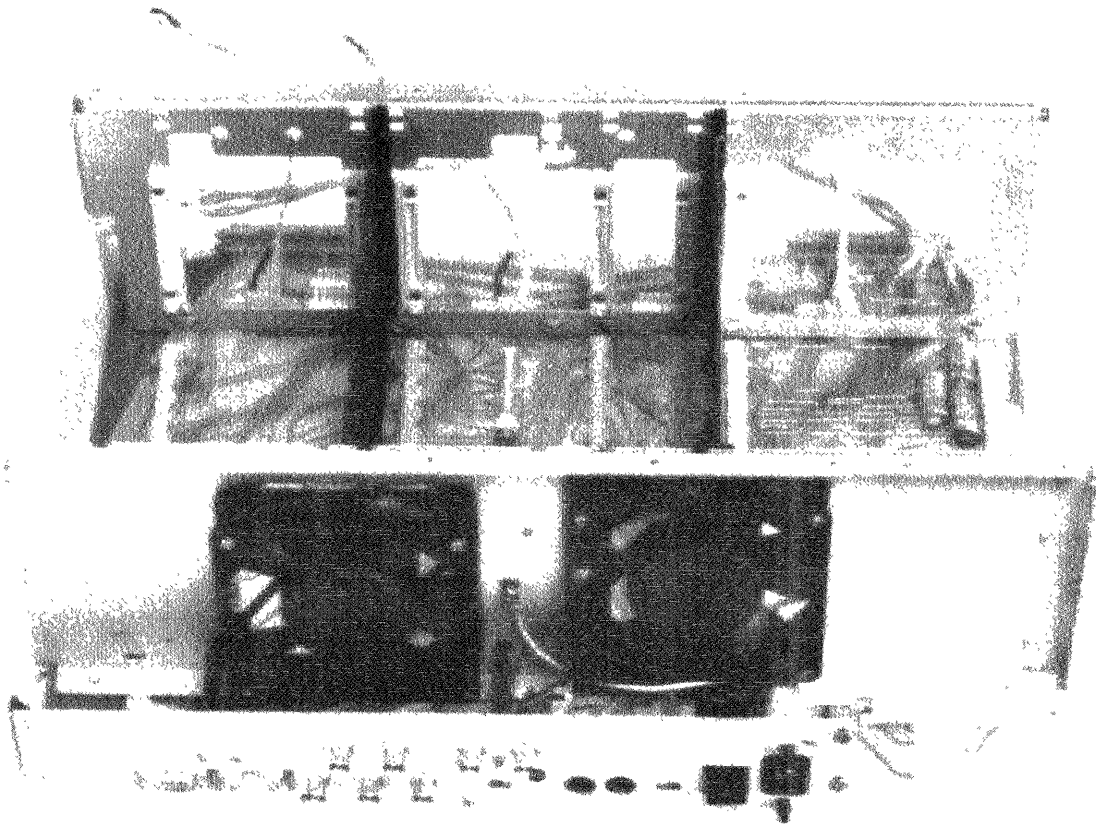

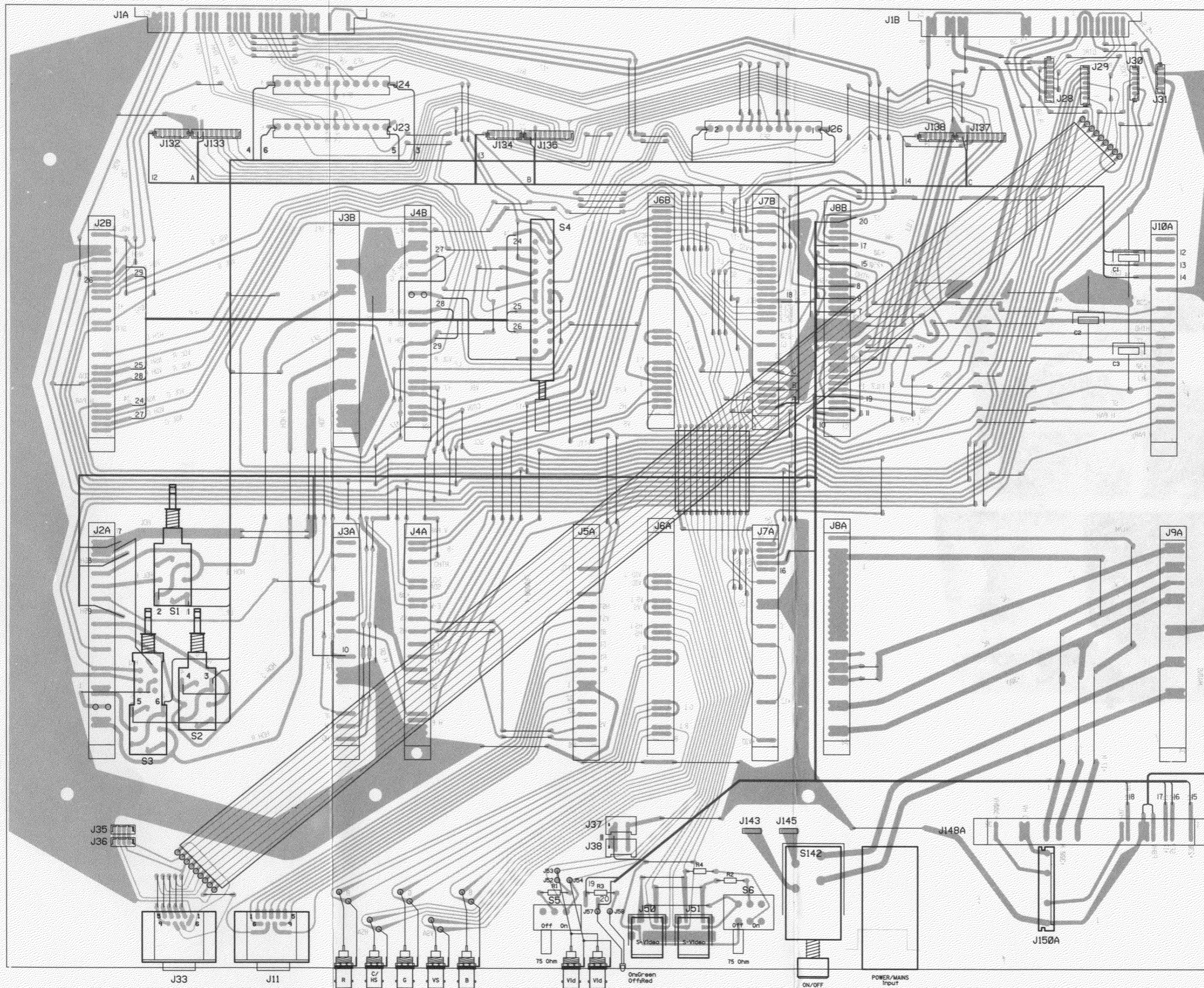

- J1A & J1B : Convergence
- J2A & J2B : N.S. correction + horizontal shift
- J3A & J3B : Horizontal deflection
- J4A & J4B : Vertical deflection
- J5A : RGB-TTL Input
- J6A & J6B : RGB-analog Input + Input switching
- J7A & J7B : Decoder
- J8A & J8B : SM power supply
- J9A : Mains input
- J10A : Electrical focus
- J11 : RGB-TTL Input (D9)
- J23,24,26 : Deflection & convergence coils
- J28,29,30,31 : Controller
- J33 : Communication Remote - RCW95
- J35 : IR receiver rear
- J36 : Build In remote control
- J37 & J38 : Fans
- J50 & J51 : S-Video Input
- J32,34,38 : RGB-output (output)
- J33,35,37 : RGB-output (input)
- J148A : EHT
- J150A : Quadrupler

To Splitter

| Name                     | Frame | Article nr. |
|--------------------------|-------|-------------|
| Date                     | Drawn | Checked     |
| 12/06/1991               | PGOE  | CD          |
| BARCO PROJECTION SYSTEMS |       |             |

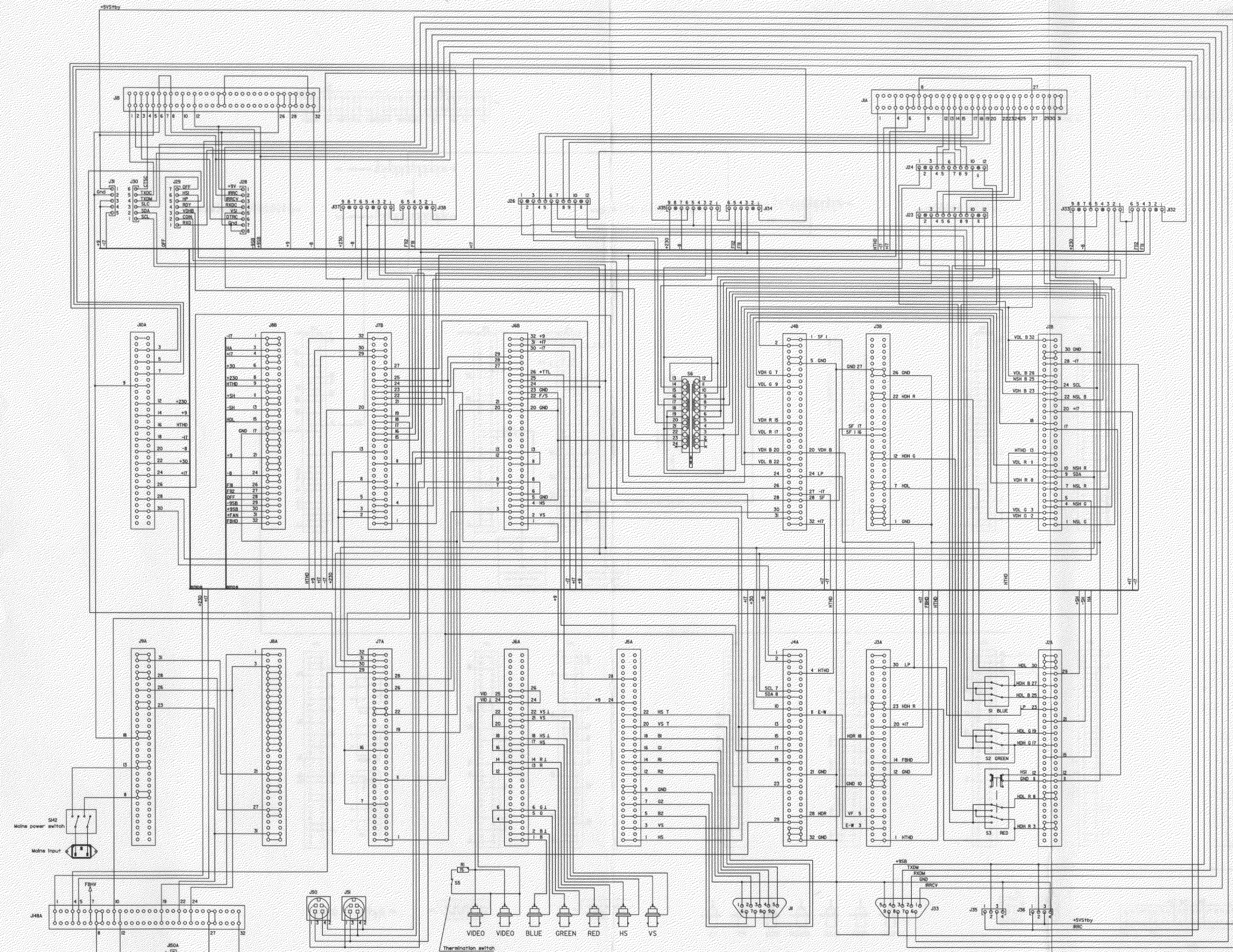

# Main frame Interconnection Scan fall

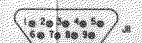
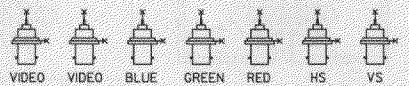
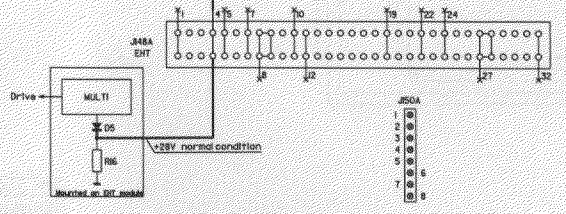
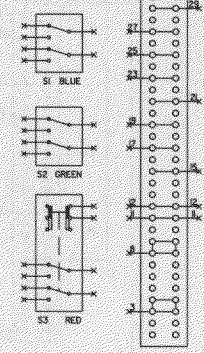
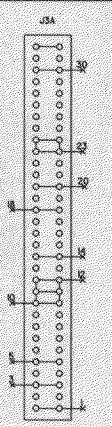
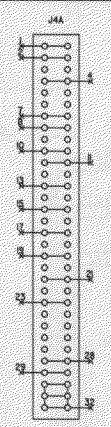
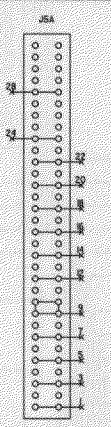
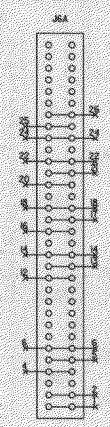
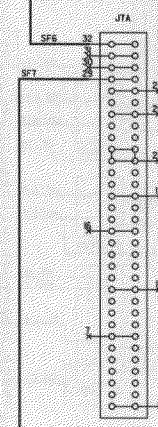
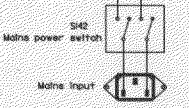
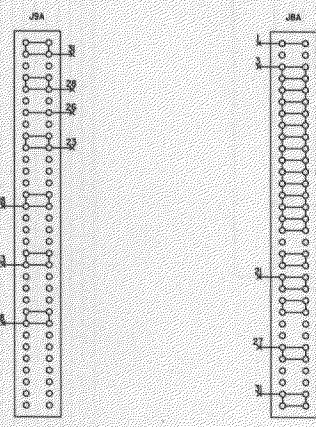
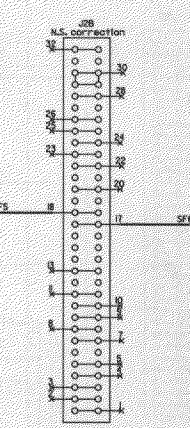
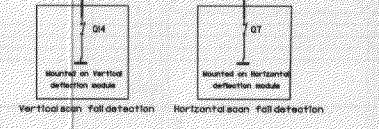
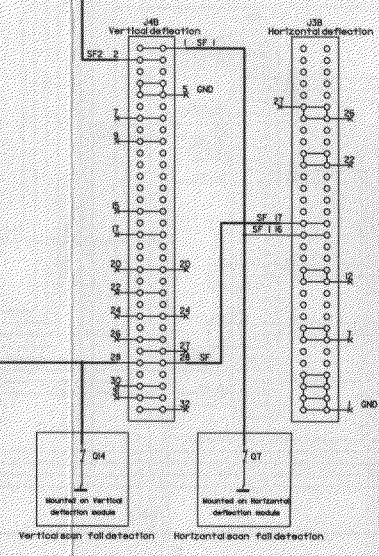
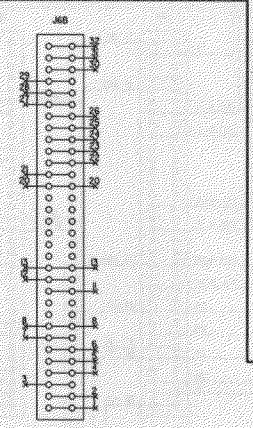
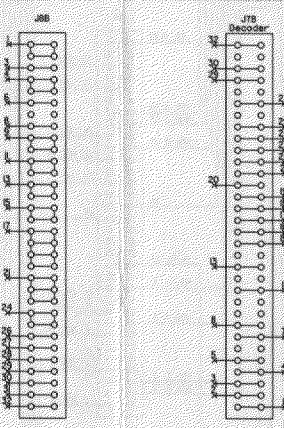
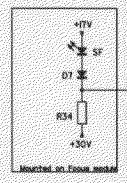
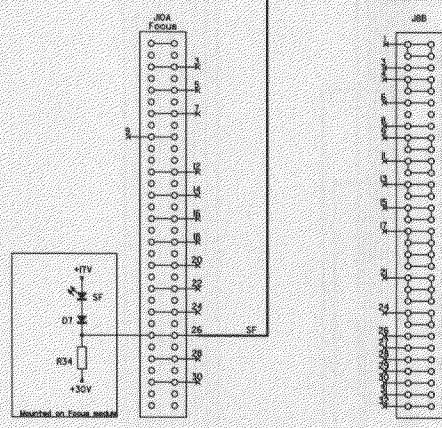
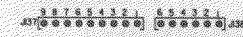
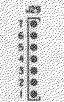
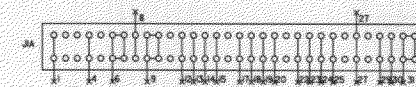
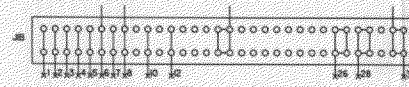

## PARTSLISTING ON BOARD LEVEL

|          |      |                               |          |      |                               |
|----------|------|-------------------------------|----------|------|-------------------------------|
| 76 15485 | 2060 | UN MAINS PJ 49 GR800 INP      | 76 17596 | 30.2 | UN CRT SOC PJ B 49 GR800      |
| 76 1740  | 0210 | UN FAN PJ 49 GR800 L100       | 76 1765  | 20.. | UN N-S PJ 49 GR800            |
| 76 1742  | 2080 | UN EHT PJ 49 GR800            | 76 1766  | 2010 | UN HOR PJ 49 GR800            |
| 76 1743  | 2090 | UN EHT PJ 49 GR800 QUADRUPLER | 76 1768  | 2020 | UN VER+SYN PJ 49 GR800        |
| 76 1744  | 3070 | UN EHT PJ 49 GR800 SPLITTER   | 76 1770  | 2050 | UN SMP PJ 49 GR800            |
| 76 1745  | 2070 | UN FOC CTRL PJ 49 GR800       | 76 1772  | 40.. | UN CONV PJ 49 GR800           |
| 76 1748  | 2030 | UN INP PJ 49 GR800 RGB+SWITCH | 76 1773  | 50.. | UN CTRL PJ 49 GR800           |
| 76 1749  | 2100 | UN INP PJ 49 GR800 TTL        | 76 1775  | 16.. | UN FRAME PJ 49 -UN GR800      |
| 76 1750  | 2110 | UN RGB PJ 49 GR800 OUTPUT     | 76 17802 | 11.. | UN CRT PJ 49 07MP DEF GR800 R |
| 76 1753  | 2040 | UN DEC PJ 49 GR800 Q          | 76 17805 | 11.1 | UN CRT PJ 49 07MP DEF GR800 G |
| 76 17592 | 30.. | UN CRT SOC PJ R 49 GR800      | 76 17806 | 11.2 | UN CRT PJ 49 07MP DEF GR800 B |
| 76 17595 | 30.1 | UN CRT SOC PJ G 49 GR800      | 76 1781  | 2140 | UN REC PJ 49 GR800 REAR       |

## PARTSLISTING ON COMPONENT LEVEL

|          |      |                               |        |          |      |                                |
|----------|------|-------------------------------|--------|----------|------|--------------------------------|
| 39 5300  |      | TAPE RUBBER 18X8              | BLA    | 32 4148  | S6.. | SWITCH SLIDE 2U S PC L202 C&K  |
| 39 5300  |      | TAPE RUBBER 18X8              | BLA    | 36 7435  | 0010 | RIVET P AL AL AD34ABS D2,4     |
| 39 5307  |      | TAPE RUBBER 6X3               | BLA    | 36 7699  | 0010 | RIVET CHOBERT D2,38 L6,35      |
| 11 1164  | C... | CAP ELAX 1000M T 25           |        | 42 02262 | 0010 | KNOB PUSH RED                  |
| 31 35722 | J... | CONN MT MBT P 3 2,5 RED       |        | 36 7452  | 0011 | RIVET P AL FE TAP/D/BS329 D2,4 |
| 31 36078 | J... | CONN SL MBT P 8 POL           |        | 36 7455  | 0020 | RIVET P AL FE TAP/D/BS46 D3,2  |
| 31 3924  | J... | CONN CT-MT MBT P 4            |        | 34 8019  | 0030 | WIRE TIE L100                  |
| 31 35000 | J11. | CONN DE09 MBS P 9 4.40 2.84   |        | 34 2007  | 0040 | CABLE FLAT (1X0,50)12          |
| 31 3526  | J11A | CONN EURO FBT P64             |        | 80 2864  | 0100 | FRAME PJ 49 FRAME MECH CPL     |
| 31 3926  | J132 | CONN CT-MT MBT P 6            |        | 80 2610  | 0101 | FRAME PJ 49 UN FRONT           |
| 31 3926  | J134 | CONN CT-MT MBT P 6            |        | 80 2611  | 0102 | FRAME PJ 49 UN REAR            |
| 31 3926  | J138 | CONN CT-MT MBT P 6            |        | 80 2612  | 0103 | FRAME PJ 49 UN MIDDLE          |
| 31 3454  | J143 | CONN TAB MBT T 0,5 4,8        |        | 80 2865  | 0104 | FRAME PJ 49 SCREEN MIDDLE 2    |
| 31 3454  | J145 | CONN TAB MBT T 0,5 4,8        |        | 72 1560  | 0105 | GUID PJ PCB SHORT              |
| 31 3530  | J1A. | CONN EURO FBS P64             |        | 36 7434  | 0106 | RIVET P AL AL AD32ABS D2,4     |
| 31 3530  | J1B. | CONN EURO FBS P64             |        | 36 7455  | 0107 | RIVET P AL FE TAP/D/BS46 D3,2  |
| 31 3468  | J23. | CONN SL MBT P12 POL           |        | 34 8002  | 0212 | GROMMET T1 D 6                 |
| 31 3468  | J24. | CONN SL MBT P12 POL           |        | 80 1829  | 0213 | NUT SC FIX FAN DC GRAPHIC      |
| 31 3468  | J26. | CONN SL MBT P12 POL           |        | 36 20306 | 0214 | SCREW DIN84 M 3 X30 MP-        |
| 31 3526  | J2A. | CONN EURO FBT P64             |        | 80 2947  | 0220 | SCREEN PJ 49 GR00 MUMETAL FAN  |
| 31 3526  | J2B. | CONN EURO FBT P64             |        | 39 53261 | 0221 | TAPE GLUE TRANSF1 " 25,4 PO2   |
| 31 35010 | J33. | CONN DE09 FBS P 9 4.40 2.84   |        | 80 2948  | 0222 | TAPE RUBBER 18X8 BLACK 18MM    |
| 31 3924  | J35. | CONN CT-MT MBT P 4            |        | 36 23268 | 0230 | SCREW DIN933 M 4 X10 MPH       |
| 31 3526  | J3A. | CONN EURO FBT P64             |        | 36 7503  | 0231 | WASHER DIN6798 A 4,3           |
| 31 3526  | J3B. | CONN EURO FBT P64             |        | 36 61036 | 0232 | NUT DIN934 M 4 HEXAGON         |
| 31 3526  | J4A. | CONN EURO FBT P64             |        | 36 7455  | 0240 | RIVET P AL FE TAP/D/BS46 D3,2  |
| 31 3526  | J4B. | CONN EURO FBT P64             |        | 80 2648  | 0250 | SPACER L69,5 H 7 M3 MS         |
| 31 3851  | J50. | CONN M-DIN FBS P 4            | SVHS   | 36 20226 | 0251 | SCREW DIN84 M 3 X 8 MP-        |
| 31 3851  | J51. | CONN M-DIN FBS P 4            | SVHS   | 36 75256 | 0252 | WASHER DIA 3,1 X 6,2 T0,6 J    |
| 31 3526  | J5A. | CONN EURO FBT P64             |        | 34 20091 | 0260 | WIRE TIE FIX 5 TM2             |
| 31 3526  | J6A. | CONN EURO FBT P64             |        | 36 26696 | 0400 | SCREW DIN921 M 3 X 8 MP-       |
| 31 3526  | J6B. | CONN EURO FBT P64             |        | 72 0908  | 0500 | KNOB PUSH 32                   |
| 31 3526  | J7A. | CONN EURO FBT P64             |        | 80 2637  | 0500 | CASE PJ 49 UN CONN PLATE       |
| 31 3526  | J7B. | CONN EURO FBT P64             |        | 31 31401 | 0510 | CONN BNC FCT P 1 50E R L       |
| 31 3526  | J8A. | CONN EURO FBT P64             |        | 36 7533  | 0511 | WASHER LOCK BNC 1-329492-1     |
| 31 3526  | J8B. | CONN EURO FBT P64             |        | 80 0762  | 0512 | SOLDERLUG SCREW 1TAG D9,8 L24  |
| 31 3526  | J9A. | CONN EURO FBT P64             |        | 36 20236 | 0521 | SCREW DIN84 M 3 X10 MP-        |
| 78 0000  | PC.. | PC PJ 49 FRAME *800           | 761775 | 80 0949  | 0522 | SPRING PJ 45 MAINS CONN FIX    |
| 71 6382  | PC.. | PC PJ 45 FRAME HR FLASH       | 761391 | 36 7502  | 0523 | WASHER DIN6798 A 3,2           |
| 10 11231 | R... | RES CF 75E J 0W25             |        | 80 2650  | 0530 | DPL PJ 49 FIX BRACKET B        |
| 10 1132  | R... | RES CF 470E J 0W25            |        | 36 26696 | 0531 | SCREW DIN921 M 3 X 8 MP-       |
| 10 11231 | R..1 | RES CF 75E J 0W25             |        | 36 7454  | 0533 | RIVET P AL FE TAP/D/BS44 D3,2  |
| 10 11231 | R..2 | RES CF 75E J 0W25             |        | 80 2649  | 0540 | DPL PJ 49 FIX BRACKET A        |
| 32 47155 | S1.. | SWITCH F 2U MAINS             |        | 36 26696 | 0541 | SCREW DIN921 M 3 X 8 MP-       |
| 32 4792  | S142 | SWITCH MAINS JPZ 2A 5/80A PC  |        | 13 1674  | 0550 | DIODE L56-EGW LED D5 RED/GRE   |
| 32 47155 | S2.. | SWITCH F 2U MAINS             |        | 13 1649  | 0551 | DIODE Q62901 LED D5 HOLDER     |
| 32 4793  | S3.. | SWITCH F 2U+F2U MAINS         |        | 80 2948  | 0560 | TAPE RUBBER 18X8 BLACK 18MM    |
| 32 4791  | S4.. | SWITCH F 8U                   |        | 13 0938  | 10.. | LENS USPL HD8                  |
| 32 4147  | S5.. | SWITCH SLIDE 1U S PC L102 C&K |        | 32 4392  | 1000 | FAN 12V 33LS 38DB 119 2700RPM  |

|          |      |                                |          |      |                                |
|----------|------|--------------------------------|----------|------|--------------------------------|
| 36 23348 | 1010 | SCREW DIN933 M 5 X20 MPH       | 80 2776  | 1650 | SCREW SC M5 H8 PJ 49 FRAME-CAS |
| 31 3037  | 1010 | CONN CIS FWT C 3 CASE          | 80 2695  | 17.. | REM CTRL PJ 49 CASE CPL        |
| 36 73796 | 1011 | WASHER DIN125 A 5,3            | 80 2639  | 1720 | CASE PJ 49 BOX CSB TURN PIN    |
| 31 3290  | 1011 | CONN CIS FWT P 1 REEL          | 80 2694  | 1721 | REM CTRL PJ 49 FIX RUBBER      |
| 80 2698  | 14.. | FRAME PJ 49 HD8 PLATE DOWN     | 36 6103  | 1730 | NUT DIN934 M 4 HEXAGON         |
| 80 2743  | 1420 | FRAME PJ 49 HD8 NUT FIX LEFT   | 36 7503  | 1731 | WASHER DIN6798 A 4,3           |
| 80 2748  | 1421 | FRAME PJ 49 HD8 NUT LOCKING    | 80 2510  | 1732 | WASHER DIA 4,5 X18 T2 *MS      |
| 80 2742  | 1422 | FRAME PJ 49 HD8 NUT            | 72 2201  | 19.. | CASE PJ 49 CASE DOWN           |
| 36 7457  | 1423 | RIVET P AL FE TAP/D/BS410 D3,2 | 80 2600  | 1900 | FRAME PJ 49 CASE BASE PLATE    |
| 80 2685  | 1424 | FRAME PJ 49 HD8 SCREW SHORT    | 36 23335 | 1901 | SCREW DIN933 M 5 X16 TWOLOK    |
| 80 2744  | 1430 | FRAME PJ 49 HD8 NUT FIX RIGHT  | 36 23335 | 1902 | SCREW DIN933 M 5 X16 TWOLOK    |
| 80 2748  | 1431 | FRAME PJ 49 HD8 NUT LOCKING    | 36 23335 | 1903 | SCREW DIN933 M 5 X16 TWOLOK    |
| 80 2742  | 1432 | FRAME PJ 49 HD8 NUT            | 72 1721  | 1911 | HINGE PJ 43 CASE               |
| 36 7457  | 1433 | RIVET P AL FE TAP/D/BS410 D3,2 | 80 0307  | 1912 | HINGE PJ 43 PLATE FIX          |
| 80 2685  | 1434 | FRAME PJ 49 HD8 SCREW SHORT    | 36 19265 | 1913 | SCREW DIN965 M 4 X16 MC+       |
| 80 2682  | 1450 | SCREW PJ 49 FIX LENS           | 80 2624  | 1920 | REM CTRL PJ 49 MOUNTING PLATE  |
| 80 2746  | 1470 | FRAME PJ 49 HD8 PL SOLID R     | 36 1915  | 1921 | SCREW DIN965 M 3 X12 MC+       |
| 36 23265 | 1471 | SCREW DIN933 M 4 X10 TWOLOK    | 80 2673  | 1922 | WASHER DIA16 X 4 T1,5 MS       |
| 31 3329  | 1472 | BUSHING SNAP DIA30,15/24       | 36 7355  | 1923 | WASHER DIN2093 12,5X6,2X0,7    |
| 80 2747  | 1480 | FRAME PJ 49 HD8 PL SOLID L     | 36 6102  | 1924 | NUT DIN934 M 3 HEXAGON         |
| 36 23265 | 1481 | SCREW DIN933 M 4 X10 TWOLOK    | 36 26696 | 1925 | SCREW DIN921 M 3 X 8 MP-       |
| 31 3329  | 1482 | BUSHING SNAP DIA30,15/24       | 80 2863  | 1926 | REM CTRL PJ 49 INTERMED PLATE  |
| 80 2745  | 1490 | FRAME PJ 49 HD8 FIX SPLITTER   | 36 26696 | 2061 | SCREW DIN921 M 3 X 8 MP-       |
| 36 23265 | 1491 | SCREW DIN933 M 4 X10 TWOLOK    | 36 26696 | 2071 | SCREW DIN921 M 3 X 8 MP-       |
| 36 23278 | 1492 | SCREW DIN933 M 4 X12 MPH       | 36 23265 | 2072 | SCREW DIN933 M 4 X10 TWOLOK    |
| 36 73786 | 1493 | WASHER DIN125 B 4,3            | 36 61036 | 2073 | NUT DIN934 M 4 HEXAGON         |
| 80 2699  | 15.. | FRAME PJ 49 HD8 PLATE UP GR800 | 36 26696 | 2081 | SCREW DIN921 M 3 X 8 MP-       |
| 36 23265 | 1501 | SCREW DIN933 M 4 X10 TWOLOK    | 79 1636  | 2120 | UN TRAMIT PJ 49 IR RCU800      |
| 36 23335 | 1502 | SCREW DIN933 M 5 X16 TWOLOK    | 79 1637  | 2130 | UN TRAMIT PJ 49 WIRE RCU800    |
| 80 2696  | 1610 | FRAME PJ 49 HD8 UN/CRT LEFT 07 | 36 7435  | 2141 | RIVET P AL AL AD34ABS D2,4     |
| 36 23265 | 1611 | SCREW DIN933 M 4 X10 TWOLOK    | 72 2276  | 22.. | LOCK PJ 49 PCB CPL             |
| 36 20226 | 1612 | SCREW DIN84 M 3 X 8 MP-        | 72 2285  | 2201 | LOCK PJ 49 PCB CPL TTL         |
| 36 75256 | 1613 | WASHER DIA 3,1 X 6,2 T0,6 J    | 36 7435  | 2210 | RIVET P AL AL AD34ABS D2,4     |
| 72 2241  | 1614 | GUID PJ 49 PCB LONG            | 80 2877  | 2220 | LOCK PJ 49 PCB TTL PRINT       |
| 36 7456  | 1615 | RIVET AL FE TAP/D/BS48 D3,2    | 36 7434  | 2221 | RIVET P AL AL AD32ABS D2,4     |
| 72 1560  | 1616 | GUID PJ PCB SHORT              | 36 7448  | 2222 | RIVET P AL AL AD36ABS D2,4     |
| 36 7456  | 1617 | RIVET AL FE TAP/D/BS48 D3,2    | 36 23278 | 3071 | SCREW DIN933 M 4 X12 MPH       |
| 36 20236 | 1618 | SCREW DIN84 M 3 X10 MP-        | 72 1850  | 3072 | CLIPS PROTECTION TRIMPOT CEMH  |
| 36 7502  | 1619 | WASHER DIN6798 A 3,2           | 80 2675  | 4010 | FRAME PJ 49 CONV FIX BRACK R   |
| 36 20226 | 1620 | SCREW DIN84 M 3 X 8 MP-        | 36 20226 | 4011 | SCREW DIN84 M 3 X 8 MP-        |
| 36 7502  | 1621 | WASHER DIN6798 A 3,2           | 36 7502  | 4012 | WASHER DIN6798 A 3,2           |
| 80 2609  | 1625 | FRAME PJ 49 CONV SPRING        | 80 2606  | 4020 | FRAME PJ 49 CONV FIX BRACKET   |
| 36 7455  | 1626 | RIVET P AL FE TAP/D/BS46 D3,2  | 36 20226 | 4021 | SCREW DIN84 M 3 X 8 MP-        |
| 36 23265 | 1630 | SCREW DIN933 M 4 X10 TWOLOK    | 36 7502  | 4022 | WASHER DIN6798 A 3,2           |
| 36 6104  | 1631 | NUT DIN934 M 5 HEXAGON         | 80 2614  | 50.1 | FRAME PJ 49 CTRL UP            |
| 80 2697  | 1640 | FRAME PJ 49 HD8 CRT/UN RIGHT   | 72 2226  | 50.2 | FIX PJ 49 CTRL CABLE           |
| 36 23265 | 1641 | SCREW DIN933 M 4 X10 TWOLOK    | 36 20566 | 5001 | SCREW DIN84 M 4 X20 MP-        |
| 31 3329  | 1642 | BUSHING SNAP DIA30,15/24       | 80 2647  | 5002 | WASHER PJ 49 CTRL              |
| 72 2241  | 1643 | GUID PJ 49 PCB LONG            | 34 8024  | 60.. | FASTENER CABLE                 |
| 36 7456  | 1644 | RIVET AL FE TAP/D/BS48 D3,2    | 34 8024  | 6001 | FASTENER CABLE                 |
| 72 1560  | 1645 | GUID PJ PCB SHORT              | 34 8087  | 6002 | FASTENER WIRE SLCSE DIA12      |
| 36 7456  | 1646 | RIVET AL FE TAP/D/BS48 D3,2    | 34 8100  | 8100 | WIRE JUMPER 0,6 M AUTOM        |

| ITEM NO. | SIT. | DESCRIPTION                    | ITEM NO. | SIT. | DESCRIPTION                    |
|----------|------|--------------------------------|----------|------|--------------------------------|
| 34 8019  | 0100 | WIRE TIE L100                  | 34 2254  | Y375 | WIRE 7X0,16 UL1061 YEL         |
| 31 39686 | J28. | CONN CT-MT MWT P 8 INPC        | 34 2254  | Y376 | WIRE 7X0,16 UL1061 YEL         |
| 34 2254  | J281 | WIRE 7X0,16 UL1061 YEL         | 34 2254  | Y377 | WIRE 7X0,16 UL1061 YEL         |
| 34 2254  | J282 | WIRE 7X0,16 UL1061 YEL         | 34 2254  | Y379 | WIRE 7X0,16 UL1061 YEL         |
| 34 2254  | J283 | WIRE 7X0,16 UL1061 YEL         | 31 39696 | Y37E | CONN CT-MT MWT P 9 INPC        |
| 34 2254  | J284 | WIRE 7X0,16 UL1061 YEL         | 34 3036  | Y37U | CABLE COAX 50E RG178BU         |
| 34 2254  | J285 | WIRE 7X0,16 UL1061 YEL         | 34 69877 | Y37V | SLEEVE SHRINK D3,2/1,6 BLA VW1 |
| 34 2254  | J286 | WIRE 7X0,16 UL1061 YEL         | 34 69877 | Y37W | SLEEVE SHRINK D3,2/1,6 BLA VW1 |
| 34 2254  | J287 | WIRE 7X0,16 UL1061 YEL         | 34 8019  | Y37Z | WIRE TIE L100                  |
| 34 2254  | J288 | WIRE 7X0,16 UL1061 YEL         | 34 2176  | 1001 | WIRE 7X0,20 UL1007 BLU         |
| 31 4008  | J28E | CONN CT-MT FWT P 8             | 34 2114  | 1002 | WIRE 7X0,20 UL1007 WHI BLU     |
| 31 39676 | J29. | CONN CT-MT MWT P 7 INPC        | 34 2175  | 1003 | WIRE 7X0,20 UL1007 GRE         |
| 34 2254  | J291 | WIRE 7X0,16 UL1061 YEL         | 34 2112  | 1004 | WIRE 7X0,20 UL1007 WHI GRE     |
| 34 2254  | J292 | WIRE 7X0,16 UL1061 YEL         | 34 2172  | 1005 | WIRE 7X0,20 UL1007 RED         |
| 34 2254  | J293 | WIRE 7X0,16 UL1061 YEL         | 34 2111  | 1006 | WIRE 7X0,20 UL1007 WHI RED     |
| 34 2254  | J294 | WIRE 7X0,16 UL1061 YEL         | 34 2170  | 1007 | WIRE 7X0,20 UL1007 BLA         |
| 34 2254  | J295 | WIRE 7X0,16 UL1061 YEL         | 34 2173  | 1008 | WIRE 7X0,20 UL1007 ORA         |
| 34 2254  | J296 | WIRE 7X0,16 UL1061 YEL         | 34 2177  | 1009 | WIRE 7X0,20 UL1007 VIO         |
| 34 2254  | J297 | WIRE 7X0,16 UL1061 YEL         | 34 2174  | 1010 | WIRE 7X0,20 UL1007 YEL         |
| 31 4007  | J29E | CONN CT-MT FWT P 7             | 34 2178  | 1011 | WIRE 7X0,20 UL1007 GRA         |
| 31 39666 | J30. | CONN CT-MT MWT P 6 INPC        | 34 2152  | 1012 | WIRE 19X0,127 RED 1000V        |
| 34 2254  | J301 | WIRE 7X0,16 UL1061 YEL         | 34 2155  | 1013 | WIRE 19X0,127 GRE 1000V        |
| 34 2254  | J302 | WIRE 7X0,16 UL1061 YEL         | 34 2156  | 1014 | WIRE 19X0,127 BLU 1000V        |
| 34 2254  | J303 | WIRE 7X0,16 UL1061 YEL         | 34 2172  | 1015 | WIRE 7X0,20 UL1007 RED         |
| 34 2254  | J304 | WIRE 7X0,16 UL1061 YEL         | 34 2175  | 1016 | WIRE 7X0,20 UL1007 GRE         |
| 34 2254  | J305 | WIRE 7X0,16 UL1061 YEL         | 34 2171  | 1017 | WIRE 7X0,20 UL1007 BRO         |
| 34 2254  | J306 | WIRE 7X0,16 UL1061 YEL         | 34 2168  | 1018 | WIRE 7X0,20 UL1007 WHI         |
| 31 4006  | J30E | CONN CT-MT FWT P 6             | 34 2112  | 1019 | WIRE 7X0,20 UL1007 WHI GRE     |
| 31 39656 | J31. | CONN CT-MT MWT P 5 INPC        | 34 2111  | 1020 | WIRE 7X0,20 UL1007 WHI RED     |
| 34 2254  | J311 | WIRE 7X0,16 UL1061 YEL         | 34 3036  | 2021 | CABLE COAX 50E RG178BU         |
| 34 2254  | J312 | WIRE 7X0,16 UL1061 YEL         | 34 3036  | 2022 | CABLE COAX 50E RG178BU         |
| 34 2254  | J313 | WIRE 7X0,16 UL1061 YEL         | 34 3036  | 2023 | CABLE COAX 50E RG178BU         |
| 34 2254  | J314 | WIRE 7X0,16 UL1061 YEL         | 34 2209  | 3000 | CABLE FLAT AWG26 9 2.5 UL2561  |
| 34 2254  | J315 | WIRE 7X0,16 UL1061 YEL         | 34 70149 | 4000 | SLEEVE PVC D 6 BLA UL          |
| 31 4005  | J31E | CONN CT-MT FWT P 5             | 34 3036  | 5000 | CABLE COAX 50E RG178BU         |
| 31 4009  | Y33. | CONN CT-MT FWT P 9             | 34 21901 | 6000 | WIRE 19X0,25 UL1015 BLA        |
| 34 2254  | Y331 | WIRE 7X0,16 UL1061 YEL         | 34 2148  | 7000 | WIRE 0,51 UL1007 GRA           |
| 34 2254  | Y332 | WIRE 7X0,16 UL1061 YEL         | 34 10129 | 7001 | WIRE 0,51 UL1015 RED           |
| 34 2254  | Y333 | WIRE 7X0,16 UL1061 YEL         | 34 1010  | 7002 | WIRE 0,6 BLA                   |
| 34 2254  | Y335 | WIRE 7X0,16 UL1061 YEL         | 34 1011  | 7003 | WIRE 0,6 BRO                   |
| 34 2254  | Y336 | WIRE 7X0,16 UL1061 YEL         | 34 1010  | 7004 | WIRE 0,6 BLA                   |
| 34 2254  | Y337 | WIRE 7X0,16 UL1061 YEL         | 34 1010  | 7005 | WIRE 0,6 BLA                   |
| 34 2254  | Y339 | WIRE 7X0,16 UL1061 YEL         | 34 1010  | 7006 | WIRE 0,6 BLA                   |
| 31 39696 | Y33E | CONN CT-MT MWT P 9 INPC        | 31 3095  | 8000 | CONN MAINS MCT A 6 PMF         |
| 34 3036  | Y33U | CABLE COAX 50E RG178BU         | 34 2260  | 8001 | WIRE 17X0,16 UL1672 BLA 2XINS  |
| 34 69877 | Y33V | SLEEVE SHRINK D3,2/1,6 BLA VW1 | 34 2269  | 8002 | WIRE 17X0,16 UL1672 WHI 2XINS  |
| 34 69877 | Y33W | SLEEVE SHRINK D3,2/1,6 BLA VW1 | 31 34521 | 8003 | CONN REC I FWT T 0,5 4,8       |
| 34 8019  | Y33Z | WIRE TIE L100                  | 34 20499 | 8004 | WIRE 19X0,25 UL1015 YEL GRE    |
| 31 4009  | Y35. | CONN CT-MT FWT P 9             | 31 5365  | 8005 | CONN RING WT M 4 0,50/1,5      |
| 34 2254  | Y351 | WIRE 7X0,16 UL1061 YEL         | 34 7047  | 8006 | SLEEVE SHRINK D6,4/3,2 BLA VW1 |
| 34 2254  | Y352 | WIRE 7X0,16 UL1061 YEL         | 34 7047  | 8007 | SLEEVE SHRINK D6,4/3,2 BLA VW1 |
| 34 2254  | Y353 | WIRE 7X0,16 UL1061 YEL         | 34 2112  | 9024 | WIRE 7X0,20 UL1007 WHI GRE     |
| 34 2254  | Y355 | WIRE 7X0,16 UL1061 YEL         | 34 2111  | 9025 | WIRE 7X0,20 UL1007 WHI RED     |
| 34 2254  | Y356 | WIRE 7X0,16 UL1061 YEL         | 34 2114  | 9026 | WIRE 7X0,20 UL1007 WHI BLU     |
| 34 2254  | Y357 | WIRE 7X0,16 UL1061 YEL         | 34 2175  | 9027 | WIRE 7X0,20 UL1007 GRE         |
| 34 2254  | Y359 | WIRE 7X0,16 UL1061 YEL         | 34 2172  | 9028 | WIRE 7X0,20 UL1007 RED         |
| 31 39696 | Y35E | CONN CT-MT MWT P 9 INPC        | 34 2176  | 9029 | WIRE 7X0,20 UL1007 BLU         |
| 34 3036  | Y35U | CABLE COAX 50E RG178BU         | 34 6989  | 9100 | SLEEVE SHRINK D1,2/0,6 BLA     |
| 34 69877 | Y35V | SLEEVE SHRINK D3,2/1,6 BLA VW1 | 34 6989  | 9101 | SLEEVE SHRINK D1,2/0,6 BLA     |
| 34 69877 | Y35W | SLEEVE SHRINK D3,2/1,6 BLA VW1 | 34 6989  | 9102 | SLEEVE SHRINK D1,2/0,6 BLA     |
| 34 8019  | Y35Z | WIRE TIE L100                  | 34 6989  | 9103 | SLEEVE SHRINK D1,2/0,6 BLA     |
| 31 4009  | Y37. | CONN CT-MT FWT P 9             | 34 2148  | 9200 | WIRE 0,51 UL1007 GRA           |
| 34 2254  | Y371 | WIRE 7X0,16 UL1061 YEL         | 34 2148  | 9201 | WIRE 0,51 UL1007 GRA           |
| 34 2254  | Y372 | WIRE 7X0,16 UL1061 YEL         | 34 2148  | 9202 | WIRE 0,51 UL1007 GRA           |
| 34 2254  | Y373 | WIRE 7X0,16 UL1061 YEL         | 34 10129 | 9203 | WIRE 0,51 UL1015 RED           |



| ART NO.  | DESCRIPTION                    | QUANTITY | ART NO.  | DESCRIPTION                    | QUANTITY |
|----------|--------------------------------|----------|----------|--------------------------------|----------|
| 13 0938  | LENS USPL HD8                  | 3        | 36 75256 | WASHER DIA 3,1 X 6,2 T0,6 J    | 6        |
| 13 1649  | DIODE Q62901 LED D5 HOLDER     | 1        | 36 7533  | WASHER LOCK BNC 1-329492-1     | 7        |
| 13 1674  | DIODE L56-EGW LED D5 RED/GRE   | 1        | 36 7699  | RIVET CHOBERT D2,38 L6,35      | 34       |
| 31 3037  | CONN CIS FWT C 3 CASE          | 1        | 39 5300  | TAPE RUBBER 18X8 BLA           | 2        |
| 31 31401 | CONN BNC FCT P 1 50E R L       | 7        | 39 5307  | TAPE RUBBER 6X3 BLA            | 1        |
| 31 3290  | CONN CIS FWT P 1 REEL          | 2        | 39 53261 | TAPE GLUE TRANSF1 " 25,4 PO2   | 1        |
| 31 3329  | BUSHING SNAP DIA30,15/24       | 3        |          |                                |          |
| 31 3454  | CONN TAB MBT T 0,5 4,8         | 2        | 42 02262 | KNOB PUSH RED                  | 1        |
| 31 3468  | CONN SL MBT P12 POL            | 3        |          |                                |          |
| 31 35000 | CONN DE09 MBS P 9 4.40 2.84    | 1        | 72 0908  | KNOB PUSH 32                   | 1        |
| 31 35010 | CONN DE09 FBS P 9 4.40 2.84    | 1        | 72 1560  | GUID PJ PCB SHORT              | 18       |
| 31 3526  | CONN EURO FBT P64              | 16       | 72 1721  | HINGE PJ 43 CASE               | 2        |
| 31 3530  | CONN EURO FBS P64              | 2        | 72 1850  | CLIPS PROTECTION TRIMPOT CEMH  | 1        |
| 31 35722 | CONN MT MBT P 3 2,5 RED        | 2        | 72 2201  | CASE PJ 49 CASE DOWN           | 1        |
| 31 36078 | CONN SL MBT P 8 POL            | 1        | 72 2226  | FIX PJ 49 CTRL CABLE           | 2        |
| 31 3851  | CONN M-DIN FBS P 4 SVHS        | 2        | 72 2241  | GUID PJ 49 PCB LONG            | 2        |
| 31 3924  | CONN CT-MT MBT P 4             | 2        | 72 2276  | LOCK PJ 49 PCB CPL             | 6        |
| 31 3926  | CONN CT-MT MBT P 6             | 3        | 72 2285  | LOCK PJ 49 PCB CPL TTL         | 1        |
| 32 4147  | SWITCH SLIDE 1U S PC L102 C&K  | 1        | 80 0307  | HINGE PJ 43 PLATE FIX          | 2        |
| 32 4148  | SWITCH SLIDE 2U S PC L202 C&K  | 1        | 80 0762  | SOLDERLUG SCREW 1TAG D9,8 L24  | 7        |
| 32 4392  | FAN 12V 33LS 38DB 119 2700RPM  | 1        | 80 0949  | SPRING PJ 45 MAINS CONN FIX    | 2        |
| 32 47155 | SWITCH F 2U MAINS              | 2        | 80 1829  | NUT SC FIX FAN DC GRAPHIC      | 7        |
| 32 4791  | SWITCH F 8U                    | 1        | 80 2510  | WASHER DIA 4,5 X18 T2 *MS      | 1        |
| 32 4792  | SWITCH MAINS JPZ 2A 5/80A PC   | 1        | 80 2600  | FRAME PJ 49 CASE BASE PLATE    | 1        |
| 32 4793  | SWITCH F 2U+F2U MAINS          | 1        | 80 2606  | FRAME PJ 49 CONV FIX BRACKET   | 1        |
|          |                                |          | 80 2609  | FRAME PJ 49 CONV SPRING        | 1        |
| 34 2007  | CABLE FLAT (1X0,50)12          | 1        | 80 2610  | FRAME PJ 49 UN FRONT           | 1        |
| 34 20091 | WIRE TIE FIX 5 TM2             | 3        | 80 2611  | FRAME PJ 49 UN REAR            | 1        |
| 34 8002  | GROMMET T1 D 6                 | 7        | 80 2612  | FRAME PJ 49 UN MIDDLE          | 1        |
| 34 8019  | WIRE TIE L100                  | 13       | 80 2614  | FRAME PJ 49 CTRL UP            | 1        |
| 34 8024  | FASTENER CABLE                 | 8        | 80 2624  | REM CTRL PJ 49 MOUNTING PLATE  | 1        |
| 34 8087  | FASTENER WIRE SLCSE DIA12      | 2        | 80 2637  | CASE PJ 49 UN CONN PLATE       | 1        |
|          |                                |          | 80 2639  | CASE PJ 49 BOX CSB TURN PIN    | 1        |
| 36 1915  | SCREW DIN965 M 3 X12 MC+       | 1        | 80 2647  | WASHER PJ 49 CTRL              | 4        |
| 36 19265 | SCREW DIN965 M 4 X16 MC+       | 6        | 80 2648  | SPACER L69,5 H 7 M3 MS         | 2        |
| 36 20226 | SCREW DIN84 M 3 X 8 MP-        | 12       | 80 2649  | DPL PJ 49 FIX BRACKET A        | 1        |
| 36 20236 | SCREW DIN84 M 3 X10 MP-        | 3        | 80 2650  | DPL PJ 49 FIX BRACKET B        | 1        |
| 36 20306 | SCREW DIN84 M 3 X30 MP-        | 7        | 80 2673  | WASHER DIA16 X 4 T1,5 MS       | 1        |
| 36 20566 | SCREW DIN84 M 4 X20 MP-        | 4        | 80 2675  | FRAME PJ 49 CONV FIX BRACK R   | 1        |
| 36 23265 | SCREW DIN933 M 4 X10 TWOLOK    | 52       | 80 2682  | SCREW PJ 49 FIX LENS           | 2        |
| 36 23268 | SCREW DIN933 M 4 X10 MPH       | 1        | 80 2685  | FRAME PJ 49 HD8 SCREW SHORT    | 2        |
| 36 23278 | SCREW DIN933 M 4 X12 MPH       | 4        | 80 2694  | REM CTRL PJ 49 FIX RUBBER      | 2        |
| 36 23335 | SCREW DIN933 M 5 X16 TWOLOK    | 16       | 80 2695  | REM CTRL PJ 49 CASE CPL        | 1        |
| 36 23348 | SCREW DIN933 M 5 X20 MPH       | 12       | 80 2696  | FRAME PJ 49 HD8 UN/CRT LEFT 07 | 1        |
| 36 26696 | SCREW DIN921 M 3 X 8 MP-       | 14       | 80 2697  | FRAME PJ 49 HD8 CRT/UN RIGHT   | 1        |
| 36 6102  | NUT DIN934 M 3 HEXAGON         | 1        | 80 2698  | FRAME PJ 49 HD8 PLATE DOWN     | 1        |
| 36 6103  | NUT DIN934 M 4 HEXAGON         | 1        | 80 2699  | FRAME PJ 49 HD8 PLATE UP GR800 | 1        |
| 36 61036 | NUT DIN934 M 4 HEXAGON         | 4        | 80 2742  | FRAME PJ 49 HD8 NUT            | 2        |
| 36 6104  | NUT DIN934 M 5 HEXAGON         | 2        | 80 2743  | FRAME PJ 49 HD8 NUT FIX LEFT   | 1        |
| 36 7355  | WASHER DIN2093 12,5X6,2X0,7    | 1        | 80 2744  | FRAME PJ 49 HD8 NUT FIX RIGHT  | 1        |
| 36 73786 | WASHER DIN125 B 4,3            | 2        | 80 2745  | FRAME PJ 49 HD8 FIX SPLITTER   | 1        |
| 36 73796 | WASHER DIN125 A 5,3            | 12       | 80 2746  | FRAME PJ 49 HD8 PL SOLID R     | 1        |
| 36 7434  | RIVET P AL AL AD32ABS D2,4     | 13       | 80 2747  | FRAME PJ 49 HD8 PL SOLID L     | 1        |
| 36 7435  | RIVET P AL AL AD34ABS D2,4     | 20       | 80 2748  | FRAME PJ 49 HD8 NUT LOCKING    | 2        |
| 36 7448  | RIVET P AL AL AD36ABS D2,4     | 1        | 80 2776  | SCREW SC M5 H8 PJ 49 FRAME-CAS | 2        |
| 36 7452  | RIVET P AL FE TAP/D/BS329 D2,4 | 32       | 80 2863  | REM CTRL PJ 49 INTERMED PLATE  | 1        |
| 36 7454  | RIVET P AL FE TAP/D/BS44 D3,2  | 2        | 80 2864  | FRAME PJ 49 FRAME MECH CPL     | 1        |
| 36 7455  | RIVET P AL FE TAP/D/BS46 D3,2  | 38       | 80 2865  | FRAME PJ 49 SCREEN MIDDLE 2    | 1        |
| 36 7456  | RIVET AL FE TAP/D/BS48 D3,2    | 24       | 80 2877  | LOCK PJ 49 PCB TTL             | 1        |
| 36 7457  | RIVET P AL FE TAP/D/BS410 D3,2 | 4        | 80 2947  | SCREEN PJ 49 GR00 MUMETAL FAN  | 1        |
| 36 7502  | WASHER DIN6798 A 3,2           | 9        | 80 2948  | TAPE RUBBER 18X8 BLACK 18MM    | 2        |
| 36 7503  | WASHER DIN6798 A 4,3           | 3        |          |                                |          |

| ART NO.  | DESCRIPTION                 | QUANTITY | ART NO.  | DESCRIPTION                    | QUANTITY |
|----------|-----------------------------|----------|----------|--------------------------------|----------|
| 31 3095  | CONN MAINS MCT A 6 PMF      | 1        | 34 2156  | WIRE 19X0,127 BLU 1000V        | 1        |
| 31 34521 | CONN REC I FWT T 0,5 4,8    | 2        | 34 2168  | WIRE 7X0,20 UL1007 WHI         | 1        |
| 31 39656 | CONN CT-MT MWT P 5 INPC     | 1        | 34 2170  | WIRE 7X0,20 UL1007 BLA         | 1        |
| 31 39666 | CONN CT-MT MWT P 6 INPC     | 1        | 34 2171  | WIRE 7X0,20 UL1007 BRO         | 1        |
| 31 39676 | CONN CT-MT MWT P 7 INPC     | 1        | 34 2172  | WIRE 7X0,20 UL1007 RED         | 3        |
| 31 39686 | CONN CT-MT MWT P 8 INPC     | 1        | 34 2173  | WIRE 7X0,20 UL1007 ORA         | 1        |
| 31 39696 | CONN CT-MT MWT P 9 INPC     | 3        | 34 2174  | WIRE 7X0,20 UL1007 YEL         | 1        |
| 31 4005  | CONN CT-MT FWT P 5          | 1        | 34 2175  | WIRE 7X0,20 UL1007 GRE         | 3        |
| 31 4006  | CONN CT-MT FWT P 6          | 1        | 34 2176  | WIRE 7X0,20 UL1007 BLU         | 2        |
| 31 4007  | CONN CT-MT FWT P 7          | 1        | 34 2177  | WIRE 7X0,20 UL1007 VIO         | 1        |
| 31 4008  | CONN CT-MT FWT P 8          | 1        | 34 2178  | WIRE 7X0,20 UL1007 GRA         | 1        |
| 31 4009  | CONN CT-MT FWT P 9          | 3        | 34 21901 | WIRE 19X0,25 UL1015 BLA        | 1        |
| 31 5365  | CONN RING WT M 4 0.50/1,5   | 1        | 34 2209  | CABLE FLAT AWG26 9 2.5 UL2561  | 1        |
|          |                             |          | 34 2254  | WIRE 7X0,16 UL1061 YEL         | 47       |
| 34 1010  | WIRE 0,6 BLA                | 4        | 34 2260  | WIRE 17X0,16 UL1672 BLA 2XINS  | 1        |
| 34 1011  | WIRE 0,6 BRO                | 1        | 34 2269  | WIRE 17X0,16 UL1672 WHI 2XINS  | 1        |
| 34 10129 | WIRE 0,51 UL1015 RED        | 2        | 34 3036  | CABLE COAX 50E RG178BU         | 7        |
| 34 20499 | WIRE 19X0,25 UL1015 YEL GRE | 1        | 34 69877 | SLEEVE SHRINK D3,2/1,6 BLA VW1 | 6        |
| 34 2111  | WIRE 7X0,20 UL1007 WHI RED  | 3        | 34 6989  | SLEEVE SHRINK D1,2/0,6 BLA     | 4        |
| 34 2112  | WIRE 7X0,20 UL1007 WHI GRE  | 3        | 34 70149 | SLEEVE PVC D 6 BLA UL          | 1        |
| 34 2114  | WIRE 7X0,20 UL1007 WHI BLU  | 2        | 34 7047  | SLEEVE SHRINK D6,4/3,2 BLA VW1 | 2        |
| 34 2148  | WIRE 0,51 UL1007 GRA        | 4        | 34 8019  | WIRE TIE L100                  | 26       |
| 34 2152  | WIRE 19X0,127 RED 1000V     | 1        |          |                                |          |
| 34 2155  | WIRE 19X0,127 GRE 1000V     | 1        |          |                                |          |

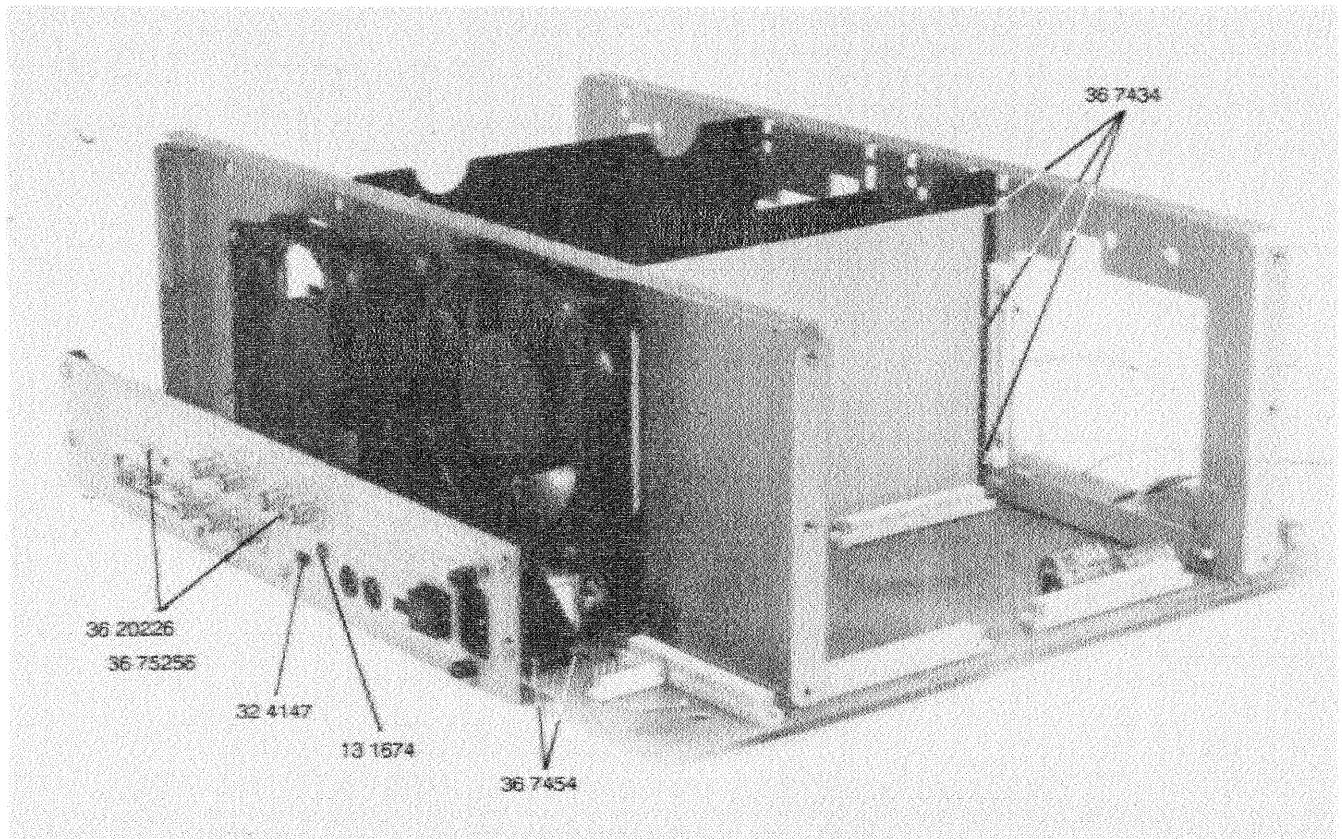
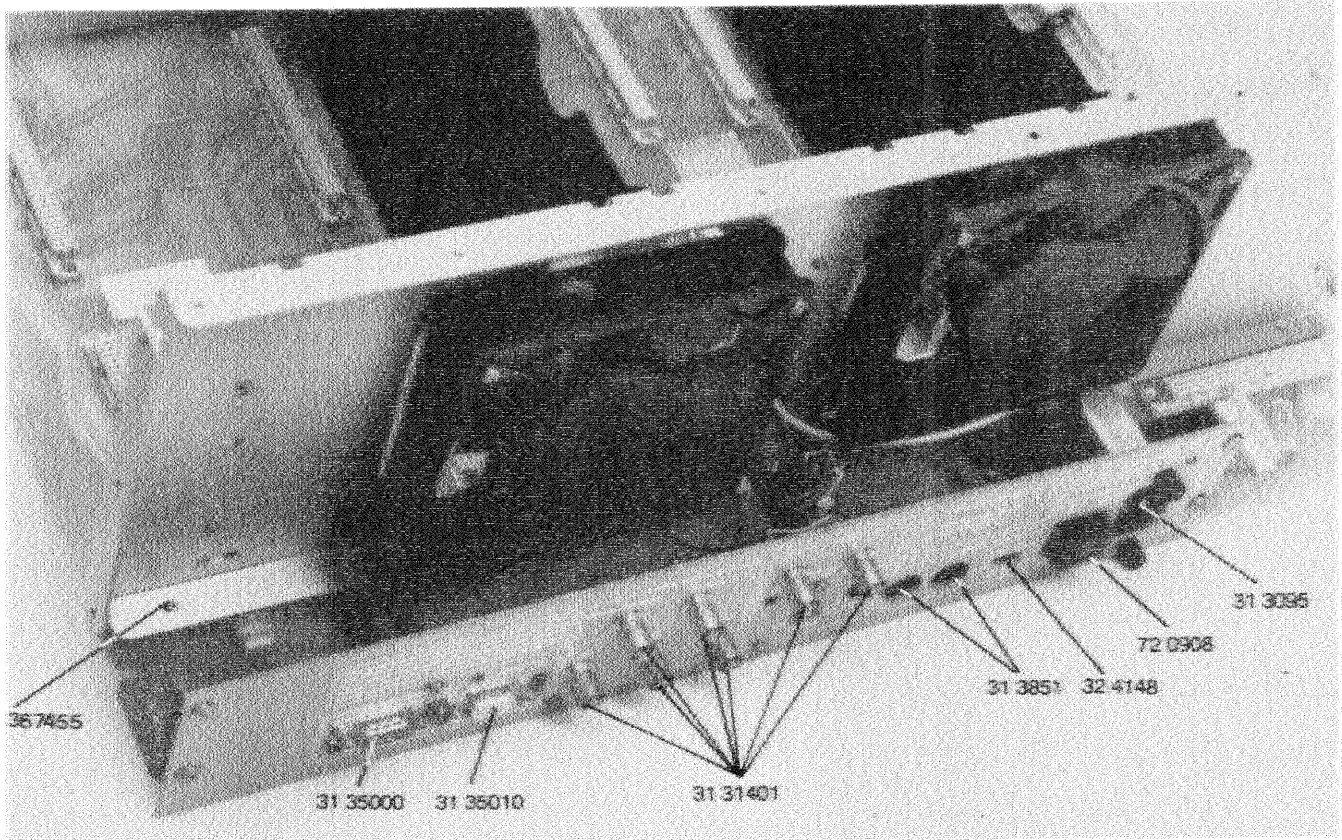

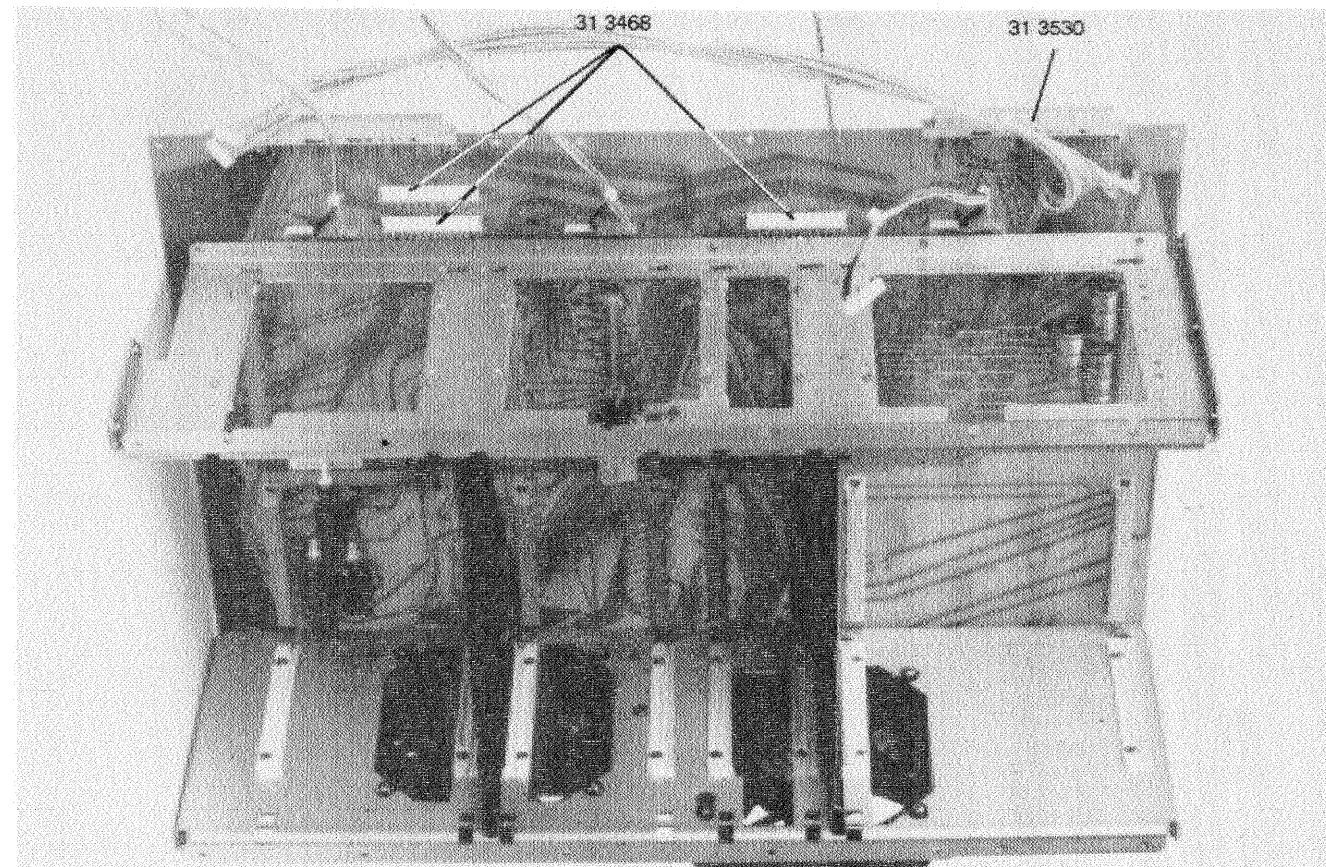
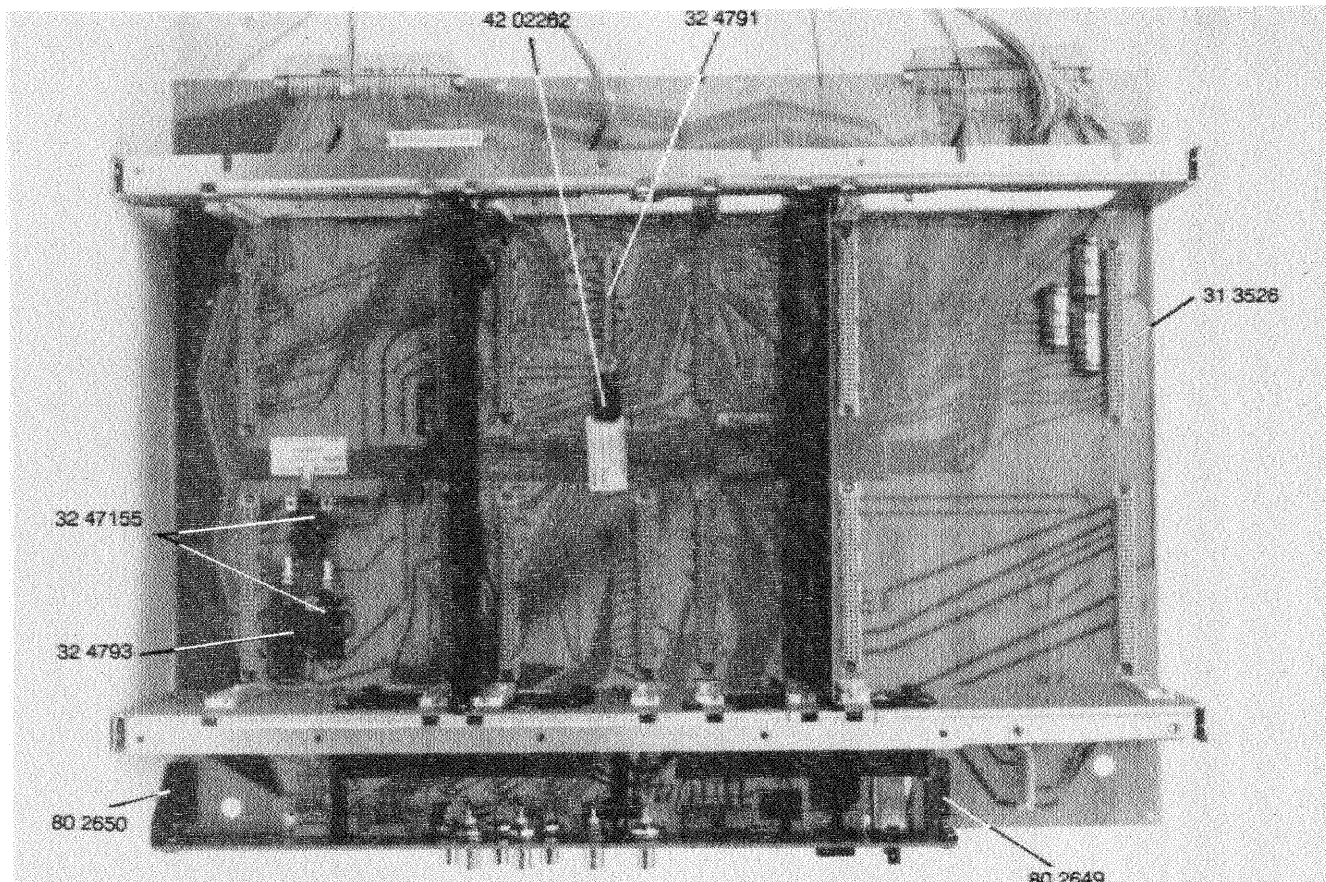

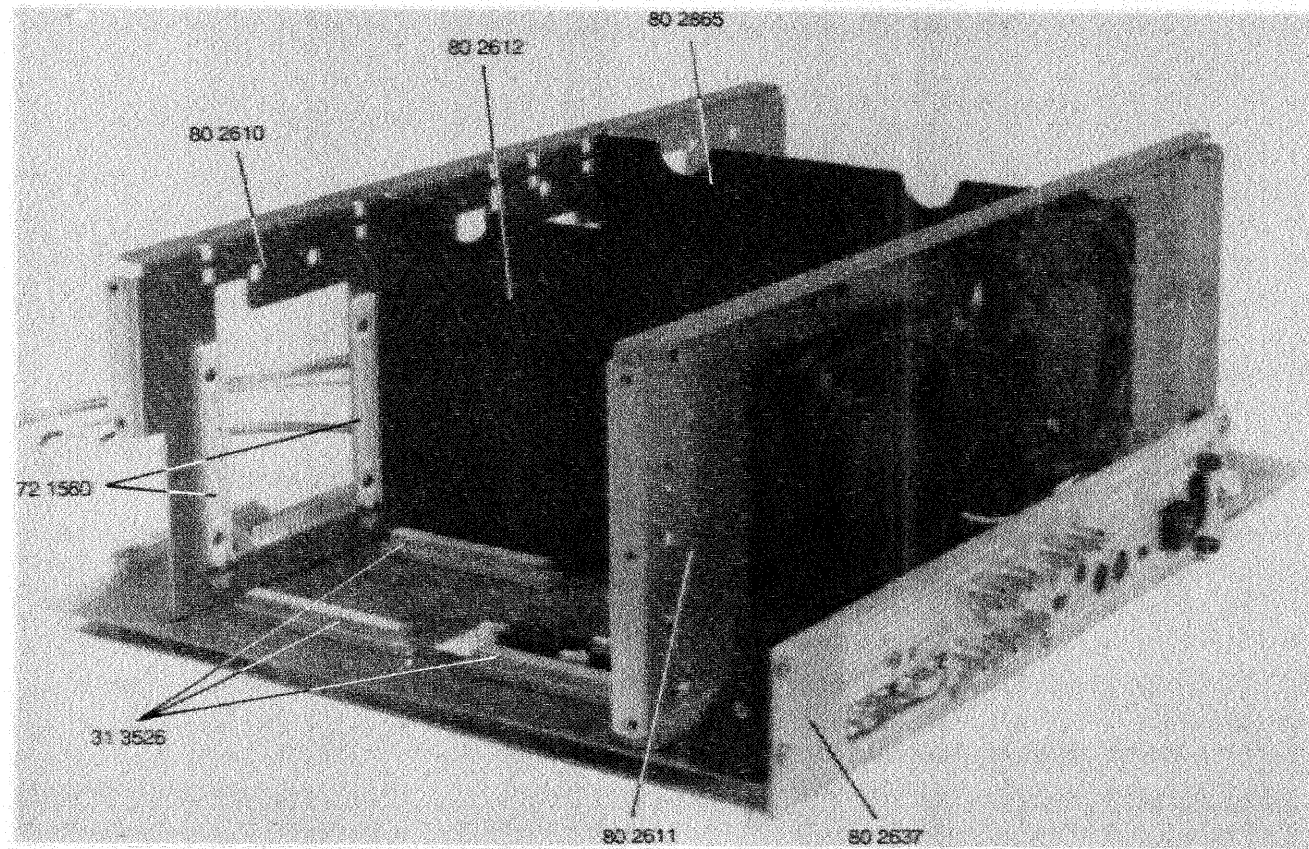
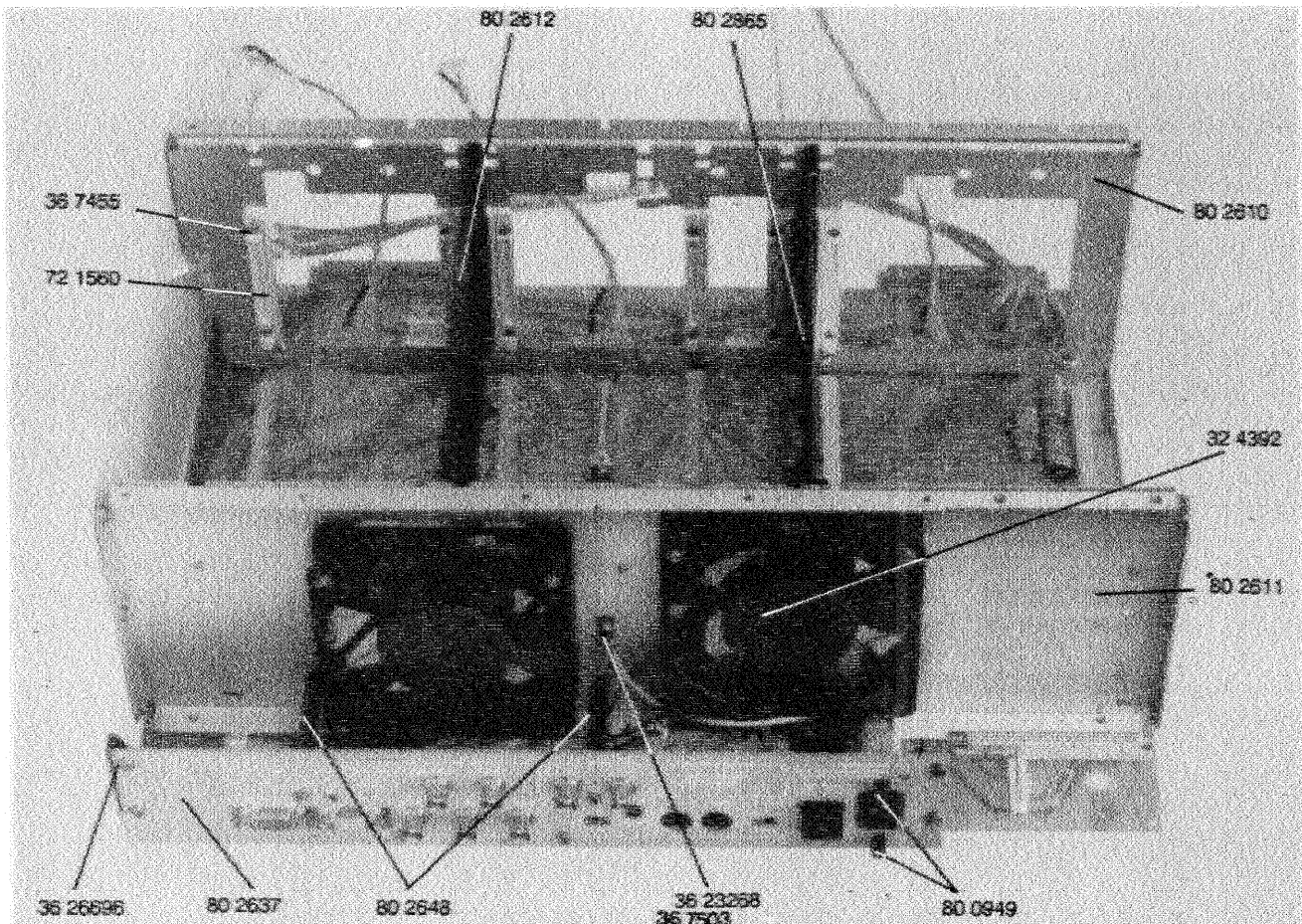

76 1744 EHT Splitter  
*replaced by*  
76 17447 EHT Splitter

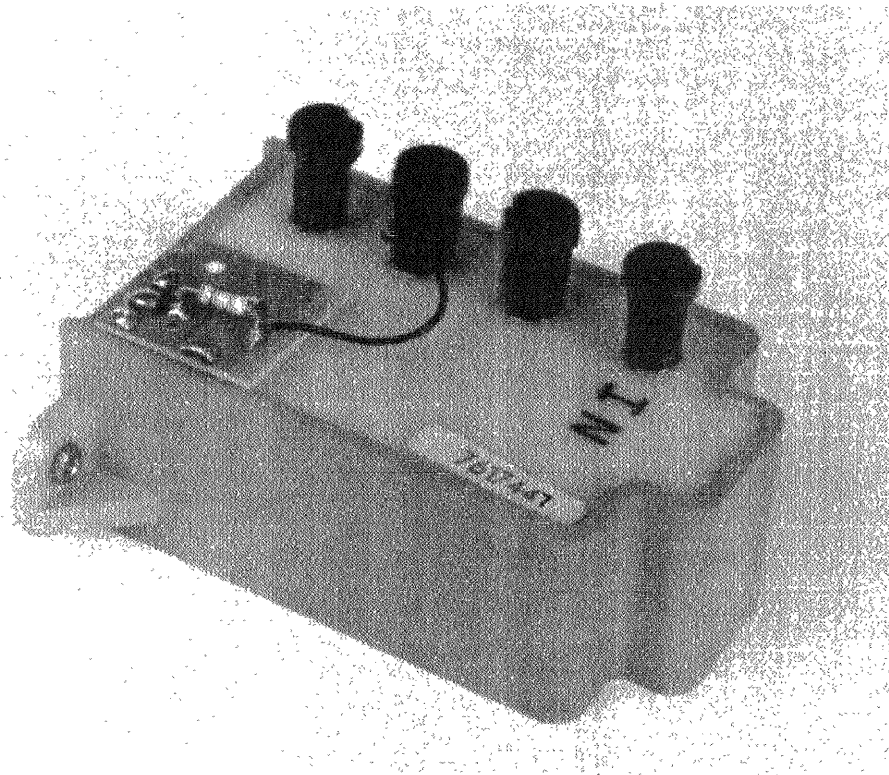

76 1743 Quadrupler

