

BARCO GRAPHICS
808s

R9000901 - R9000908

R9000902 - R9000907

INSTALLATION MANUAL

BARCO

BARCO PROJECTION SYSTEMS

BARCO

GRAPHICS
808s

R9000901 - R9000908

R9000902 - R9000907

INSTALLATION MANUAL

Due to constant research, the information in this manual is subject to change without notice.

Produced by BARCO NV, November 1997.
All rights reserved.

Trademarks are the rights of their respective owners.

Printed in Belgium

BARCO nv/Projection Systems

Noordlaan 5
B-8520 Kuurne
Belgium

Printed in Belgium

Contents

CHAPTER 1 SAFETY INSTRUCTIONS

On safety	1-1
On installation	1-2
On servicing	1-2
On cleaning	1-2
On repacking	1-2
On illumination	1-2

CHAPTER 2 UNPACKING AND PROJECTOR DIMENSIONS

Unpacking	2-1
Projector dimensions	2-2

CHAPTER 3 INSTALLATION GUIDELINES

Environment	3-1
What about ambient light ?	3-1
Which screen type?	3-1
What image size? How big should the image be?	3-1
Where to install the projector ?	3-2
Mounting Configuration	3-2

CHAPTER 4 INSTALLATION SETUP

Access to Controls	4-1
Opening the top cover	4-1
Removing the top cover	4-1
Reinstalling the top cover	4-1
Scan Adaptation	4-2
Getting access to the scan switches	4-2
Horizontal scan switches	4-2
Vertical scan switch	4-2

CHAPTER 5 PROJECTOR SETUP

Setting the projector address	5-1
Powerup mode	5-2
Operational mode	5-2
Standby mode	5-2
Baud Rate for communication with a computer	5-3
Password mode	5-3

CHAPTER 6 AC POWER CONNECTION

AC Power cord connection	6-1
Preparing your power cord	6-1
Mains lead with CEE7 plug	6-1
Power cord with an ANSI 73.11 plug	6-1
AC Power check	6-2
AC Input power voltage adaptation	6-2
Switching on the projector	6-3
Starting up with a full white image	6-3
Starting up with "warm up period"	6-3
Starting up without "warm up period"	6-3

CHAPTER 7 SOURCE CONNECTIONS

Signal input connection	7-1
Connecting a Composite Video source to Port 1	7-1
Connecting a S-Video (or Composite Video) source to Port 2	7-2
Connecting a RGB Analog source to Port 3	7-2
Connecting a RGB Analog source to Port 4/5	7-3
Connecting a Component Video source to Port 4/5	7-3
Connecting a RGB Analog source with Tri-level sync to Port 4/5 (option)	7-4
Connecting a Component Video source with Tri-level sync to Port 4/5 (option)	7-4
Peripheral equipment	7-4
Connecting a RCVDS 05 source selector to the BARCOGRAPHICS 808s	7-4
Connecting a VS05 source selector to the BARCOGRAPHICS 808s	7-4
Connecting an IR Remote Receiver 800 to the BARCOGRAPHICS 808s	7-4

CHAPTER 8 INSTALLATION ADJUSTMENT MODE

Access to Installation Adjustment Mode	8-1
Overview flowchart of the Installation Adjustment Mode	8-1
Projector Distance	8-2
Optical Lens Focusing	8-2
Raster Centering	8-3
CRT Projection Angle Adjustment	8-4
Scheimpflug Adjustment	8-6

CHAPTER 9 MESSAGES, WARNINGS AND FAILURE CODES

APPENDIX A. BARCO CEILING MOUNT SUPPORT

APPENDIX B. G2 ADJUSTMENT

APPENDIX C. GAMMA CORRECTIONS

1

SAFETY INSTRUCTIONS

Projectors are built in accordance with the requirements of the international safety standards IEC950, UL 1950 and CSA C22.2 No. 950, which are the safety standards of information technology equipment including electrical business equipment.

These safety standards impose important requirements on the use of safety critical components, materials and isolation, in order to protect the user or operator against the risk of electric shock and energy hazard, and having access to live parts.

Safety standards also impose to the internal and external temperature variations, radiation levels, mechanical stability and strength, enclosure construction and protection against risk of fire.

Simulated single fault condition testing ensures the safety of the equipment to the user even when the equipment's normal operation fails.

Installation instructions

Before operating your projector please read this manual thoroughly, and retain it for future reference.

Installation and preliminary adjustments should be performed by qualified BARCO personnel or authorized BARCO service dealers.

OWNER'S RECORD

The article number (ART. NR.) and serial number (SER. NR) are located at the rear of the projector. Copy these numbers in the spaces provided below. Refer to them whenever you call upon your BARCO dealer regarding this product.

Article number : _____

Serial number : _____

Dealer : _____

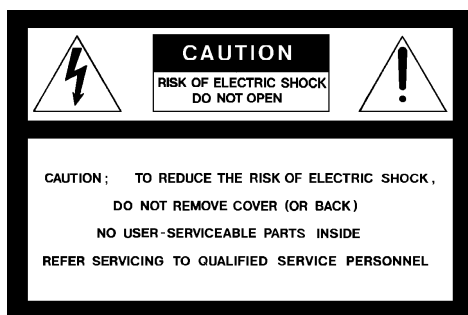

The lightning flash with an arrowhead within a triangle is intended to tell the user that parts inside this product risk electrical shock to persons.



The exclamation point within a triangle is intended to tell the user that important operating and/or servicing instructions are included in the technical documentation for this equipment.

Warning :
To prevent fire or electrical shock hazard,
do not expose this projector to rain or moisture

Federal Communication Commission (FCC statement)

This equipment has been tested and found to comply with the limits for a class B digital device, pursuant to Part 15 of the FCC Rules. These limits are designed to provide reasonable protection against harmful interference when the equipment is operated in a commercial environment. This equipment generates, uses, and can radiate radio frequency energy and, if not installed and used in accordance with the instruction manual, may cause harmful interference to radio communications. Operation of this equipment in a residential area is likely to cause harmful interference in which case the user will be required to correct the interference at his own expense.

Instructions to the user :

If this equipment does cause interference to radio or television reception, the user may try to correct the interference by one or more of the following measures :

- Re-orientate the receiving antenna for the radio or television.
- Relocate the equipment with respect to the receiver.
- Plug the equipment into a different outlet so that the equipment and receiver are on different branch circuits.
- Fasten cable connectors to the equipment with mounting screws.

Note :

The use of shielded cables is required to comply within the limits of Part 15 of FCC rules and EN55022.

General safety instructions :

- All the safety and operating instructions should be read before using this unit.
- The operating instruction manual should be retained for future reference.
- All warnings on the projector and in the documentation manuals should be adhered to.
- All instructions for operating and use of this equipment must be followed precisely.

On safety

- This product should be operated from an AC power source. Operating AC power voltage of the projector when leaving the factory:

BARCOGRAPHICS 808s

Art. No.: R9000901 (230 VAC) Art. No.: R9000908 (120 VAC)

BARCOGRAPHICS 808s with built-in Iris²

Art. No.: R9000902 (230 VAC) Art. No.: R9000907 (120 VAC)

Consult the appropriate section of this manual to switch over from 230 Vac to 120 Vac or from 120 Vac to 230 Vac.

If you are not sure of the type of AC power available, consult your dealer or local power company.

This product is equipped with a 3-wire grounding plug, a plug having a third (grounding) pin. This plug will only fit into a grounding-type power outlet. This is a safety feature. If you are unable to insert the plug into the outlet, contact your electrician to replace your obsolete outlet. Do not defeat the purpose of the grounding-type plug.

WARNING FOR THE USERS:

THIS EQUIPMENT MUST BE GROUNDED (EARTHED) via the supplied 3 conductor AC power cable. (If the supplied power cable is not the correct one, consult your dealer.)

A. Mains lead (AC Power cord) with CEE 7 plug

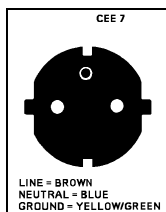

The colors of the mains lead are colored in accordance with the following code:

- Yellow + Green : Earth (Ground)
- Blue : Neutral
- Brown : Line (Live)

B. Power cord with ANSI 73.11 plug

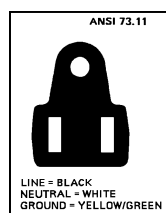

The wires of the power cord are colored in accordance with the following code.

- Yellow + Green : Earth (Ground)
- White : Neutral
- Black : Line (live)

- Do not allow anything to rest on the power cord. Do not locate this product where people will walk on the cord. To disconnect the cord, pull it out by the plug. Never pull the cord itself.
- If an extension cord is used with this product, make sure that the total of the ampere ratings on the products plugged into the extension cord does not exceed the extension cord ampere rating. Also make sure that the total of all products plugged into the wall outlet does not exceed 15 amperes.
- Never push objects of any kind into this product through cabinet slots as they may touch dangerous voltage points or short out parts that could result in a risk of fire or electrical shock.
- Never spill liquid of any kind on the product. Should any liquid or solid object fall into the cabinet, unplug the set and have it checked by qualified service personnel before resuming operations.
- Lightning - For extra protection for this video product during a lightning storm, or when it is left unattended and unused for a long period of time, unplug it from the wall outlet. This will prevent damage to the projector due to lightning and AC power-line surges.

On installation

- Do not place this projector on an unstable cart, stand, or table. The projector may fall, causing serious damage to it.
- Do not use this projector near water.
- Use only the power cord supplied with your projector. While appearing to be similar, other power cords have not been safety tested at the factory and may not be used to power the projector. For a replacement power cord, contact your dealer.
- Slots and openings in the cabinet and the sides are provided for ventilation; to ensure reliable operation of the projector and to protect it from overheating, these openings must not be blocked or covered. The openings should never be blocked by placing the product on a bed, sofa, rug, or other similar surface. This product should never be placed near or over a radiator or heat register. This projector should not be placed in a built-in installation or enclosure unless proper ventilation is provided.

On servicing

Do not attempt to service this projector yourself, as opening or removing covers may expose you to dangerous voltage potential and risk of electric shock! **Refer all projector service to a qualified BARCO service center.**

Call for service in the following conditions :

When the power cord or plug is damaged or frayed.

- If liquid has been spilled into the projector.
- If the product has been exposed to rain or water.
- If the product does not operate normally when the operating instructions are followed. Adjust only those controls that are covered by the operating instructions since improper adjustment of the other controls may result in damage and will often require extensive work by a qualified technician to restore the product to normal operation.
- If the product has been dropped or the cabinet has been damaged.
- If the product exhibits a distinct change in performance, indicating a need for service.

Replacement parts - When replacement parts are required, be sure the service technician has used original BARCO replacement parts or authorized replacement parts which have the same characteristics as the BARCO original part. Unauthorized substitutions may result in degraded performance and reliability, fire, electric shock or other hazards. Unauthorized substitutions may void warranty.

Safety check - Upon completion of any service or repairs to this projector, ask the service technician to perform safety checks to determine that the projector is in proper operating condition.

On cleaning

Unplug this product from the wall outlet before cleaning. Do not use liquid cleaners or aerosol cleaners. Use a damp cloth for cleaning.

To keep the cabinet looking brand-new, periodically clean it with a soft cloth. Stubborn stains may be removed with a cloth lightly dampened with mild detergent solution. Never use strong solvents, such as thinner or benzene, or abrasive cleaners, since these will damage the cabinet.

To ensure the highest optical performance and resolution, the projection lenses are specially treated with an anti-reflective coating, therefore : avoid touching the lens. To remove dust on the lens, use a soft dry cloth. Do not use a damp cloth, detergent solution, or thinner.

On repacking

Keep the original shipping carton and packing material; they will come in handy if you ever have to ship your projector. For maximum protection, repack your set as it was originally packed at the factory.

On illumination

In order to obtain the best quality for the projected image, it is essential that the ambient light which is allowed to fall on the screen be kept to an absolute minimum.

When installing the projector and screen, care must be taken to avoid exposure to ambient light directly on the screen. Avoid adverse illumination on the screen from direct sunlight or fluorescent lighting fixtures.

The use of controlled ambient lighting, such as incandescent spot light or a dimmer, is recommended for proper room illumination. Where possible, care should also be taken to ensure that the floors and walls of the room in which the projector is to be installed are non-reflecting, dark surfaces. Brighter surfaces will tend to reflect and diffuse the ambient light and hence reduce the contrast of the projected image on the screen.

2

UNPACKING AND PROJECTOR DIMENSIONS

Unpacking

To open the banding around the carton, pull out the clip as shown below :

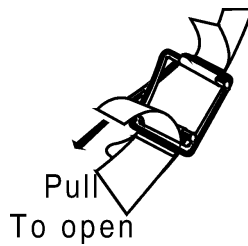

Take the projector out of its shipping carton and place it on a table.

Save the original shipping carton and packing material, which will come in handy if you ever have to ship your projector. For maximum protection, repack your projector as it was originally packed at the factory.

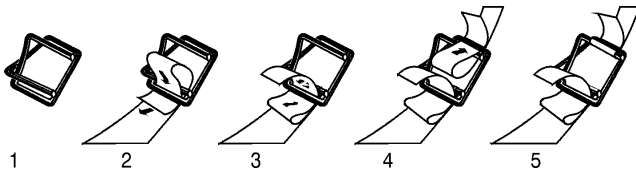

Contents of the shipping carton :

- 1 BARCOGRAPHICS 808s projector
- 1 Remote Control Unit plus 1 battery 9V
- 1 Power cord with outlet plug type CEE7 or ANSI 73.11
- 1 Owner's Manual
- 1 Installation Manual

Projector dimensions (in mm)

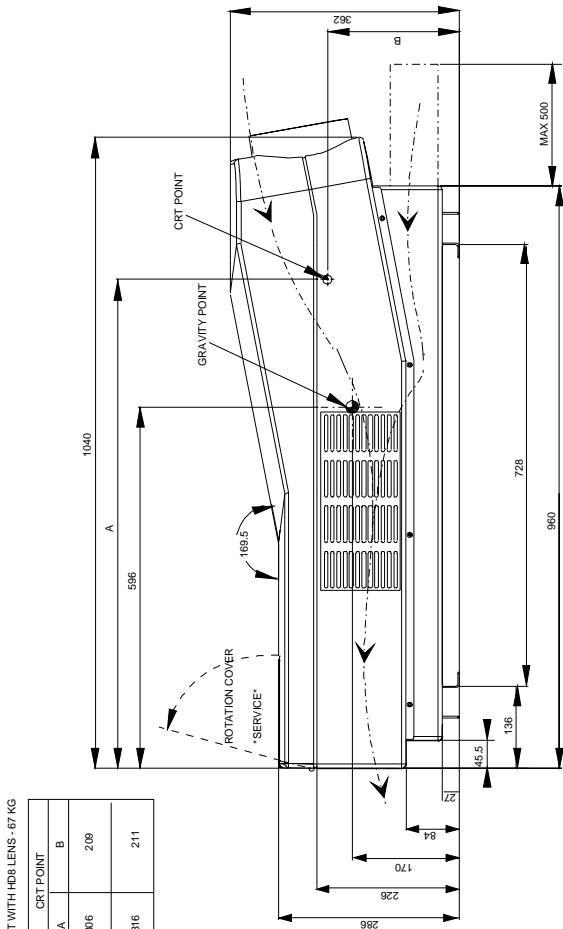

APPROXIMATE WEIGHT WITH HD8 LENS - 67 KG

CRT	CRT POINT	
	A	B
R7627612	806	209
R7627615	816	211

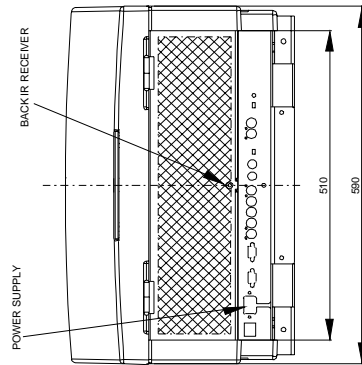
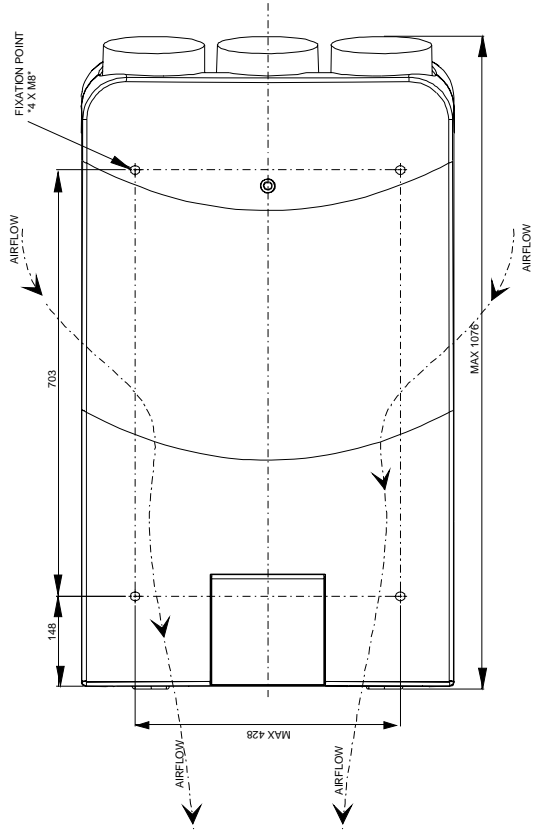
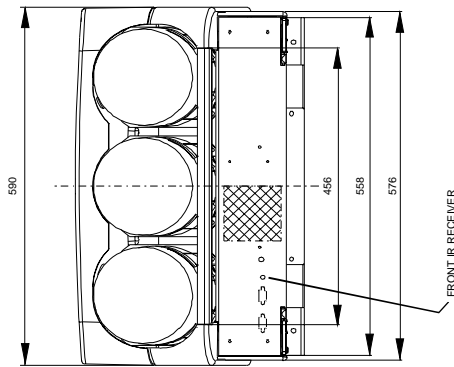

3

INSTALLATION GUIDELINES

Installation guidelines

Careful consideration of things such as image size, ambient light level, projector placement and type of screen to use are critical to optimize the use of the projection system.

Environment

Do not install the projection system in a site near heat sources such as radiators or air ducts, or in a place subject to direct sunlight, excessive dust or humidity. Be aware that room heat rises to the ceiling; Make sure the temperature near the installation site is not excessive.

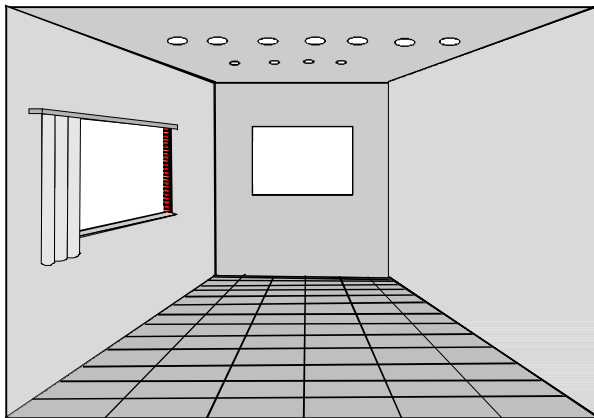

What about ambient light ?

The ambient light level of any room is made up of direct or indirect sunlight and the light fixtures in the room. The amount of ambient light will determine how bright the image will appear. So, avoid direct light on the screen as much as possible.

Windows that face the screen should be covered by opaque drapery while the set is being viewed. It is desirable to install the projecting system in a room whose walls and floor are of non-reflecting material. The use of recessed ceiling lights and a method of dimming those lights to an acceptable level is also important. Too much ambient light results in a 'wash out' of the projected image. This appears as less contrast between the darkest and lightest parts of the image. With bigger screens, the 'wash out' becomes more important. As a general rule, darken the room to the point where there is just sufficient light to read or write comfortably. Spot lighting is desirable for illuminating small areas so that interference with the screen is minimal.

Which screen type?

There are two major categories of screens used for projection equipment. Those used for front projected images and those for rear projection applications.

Screens are rated by how much light they reflect (or transmit in case of rear projection systems) given a determined amount of light projected toward them. The 'GAIN' of a screen is the term used. Front and rear screens are both rated in terms of gain. The gain of screens range from a white matte screen with a gain of 1 (x1) to a brushed aluminized screen with a gain of 10 (x10) or more. Another important consideration is the degree the screen's gain varies with the horizontal and vertical viewing angle. The choice between higher and lower gain screens is largely a matter of personal preference.

In considering the type of screen to choose, determine where the viewers will be located and go for the highest gain screen possible. A high gain screen will provide a brighter picture but reduce the viewing angle.

For more information about screens, contact your local screen supplier.

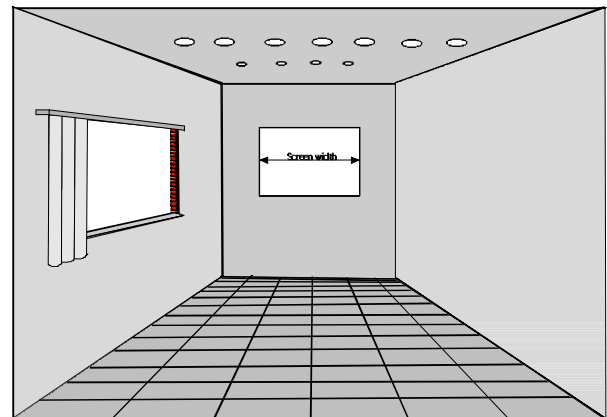

What image size? How big should the image be?

The BARCOGRAPHICS 808s is designed for projecting an image width from 1.4m (4.6') to 6m (20') with an aspect ratio of 4 to 3. It leaves the BARCO factory, adjusted as a ceiling/front projector for a screen width of 2.4m (7.8'). Changing the image size from the factory preset size requires a realignment of the projector.

Where to install the projector ?

To indicate a correct installation position it is necessary to know :

- The distance from projector to ceiling in case of Ceiling mounted or the distance from projector to floor in case of Table mounted;
- The distance from projector to screen.

To find the correct position for the BARCOGRAPHICS 808s, equipped with HD8 lenses, use the following formulas:

In metric :

$$PD[m] = 1.269 \times SW[m] + 0.344$$

$$A[cm] = 12 \times SW[m] - 28.2$$

In inch :

$$PD[inch] = 1.269 \times SW[inch] + 13.54$$

$$A[inch] = 0.12 \times SW[inch] - 11.11$$

Abbreviations used in the calculations and the drawings :

B = Distance between ceiling and top of the screen (Ceiling mounted) or distance between floor and bottom of the screen (Table mounted).

A = Correction Value, extra value to be added to B to obtain the correct installation position (In some cases the A value can be negative).

CD = Total distance between projector and ceiling (Ceiling mounted) or total distance between projector and floor (Table mounted).
 $CD = A + B$.

Ceiling Mounted : when the result is negative, enlarge the distance between ceiling and top of the screen, mount screen lower, until CD becomes zero or positive.

Table Mounted : when the result is negative, enlarge the distance between floor and bottom of the screen, mount screen higher, until CD becomes zero or positive.

SW= Screen width.

PD = Perpendicular distance between screen and projector's mount.

To obtain the right values, you can make use of the new option included in the Installation Adjustment Mode to let the projector calculate the parameters automatically. Please refer to Chapter 8 for details.

Mounting Configuration

Ceiling Mount

To install the BARCOGRAPHICS 808s in the Ceiling configuration, use BARCO'S *Ceiling Mount Kit (CM100)* - Order Number *R9827341*. Installation instructions are included with this kit.

Table Mount

BARCO offers a *heavy-duty projection table* with adjustable height which allows the projector to be correctly positioned perfectly to the installation requirements. Order Number - *R9827740*.

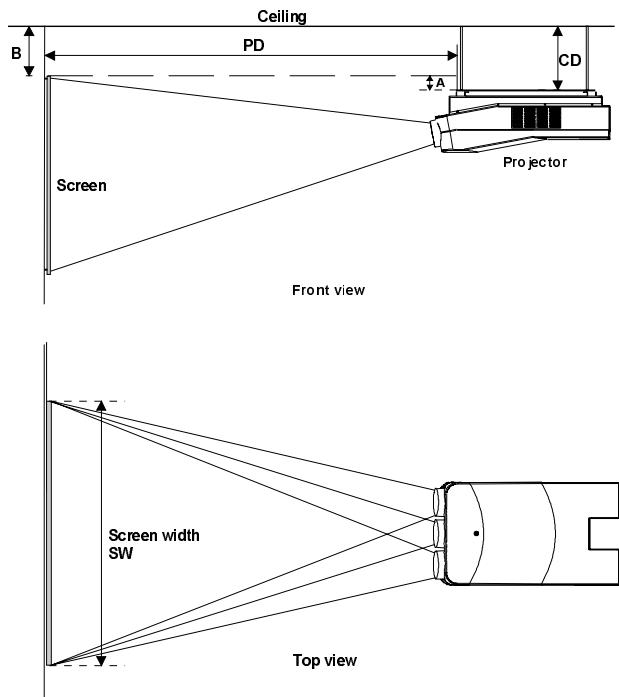

- Install the projector water levelled in both directions
- Install the projector perpendicular to the screen

Used phosphor width on the CRT faceplate (e.g. green CRT)

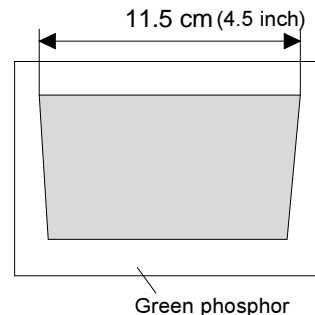

4

INSTALLATION SETUP

WARNING :
Risk of electric shock !
Installation only by BARCO authorized service personnel !

Access to Controls

Opening the top cover

During the projector setup and installation it is necessary to open the top cover. Follow the procedure described below :

- Turn the locking screw with a screwdriver counter clockwise;
- Lift up and pivot the top cover.

WARNING :

The projector's top cover is *not* supported with locking hinge. Open with care and support the cover with your hand.



Removing the top cover

During some installations, it will be convenient to remove the top cover from the projector totally.

Proceed as follows :

- Pivot the top cover backwards 90° (fully extended);
- Push carefully the top cover to the left side (viewing from the rear of the projector) until the hinges are disengaged. This can be facilitated by pressing downwards on the spring tabs next to the hinges. Slide the top cover off the projector.



Reinstalling the top cover

To reinstall the top cover on the projector :

- Place the top cover in front of the hinges (as shown in the picture) and push in the direction of the black arrow until the cover locks into the hinges;
- Pivot the top cover to close;
- Secure the locking screw by turning it clockwise with a screwdriver.

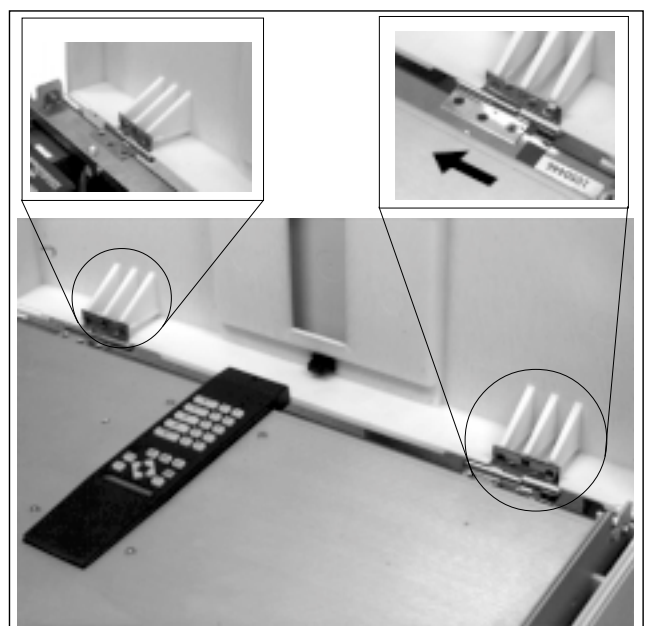

Scan Adaptation

The scan switches must be placed in the correct position which corresponds to the desired scanning configuration.

To change the scanning, it is necessary to remove the projector top cover and to open the protection plate.

For opening the projector's top cover, see 'Access to controls'.

WARNING !
TURN OFF PROJECTOR AND UNPLUG THE POWER CORD BEFORE CHANGING THE SCAN DIRECTION.

Getting access to the scan switches

- Open the top cover and remove it from the projector (see p.4-1);
- Loosen the 3 retaining screws on each side of the projector;
- Open the protection plate and pivot it forward (toward lenses).

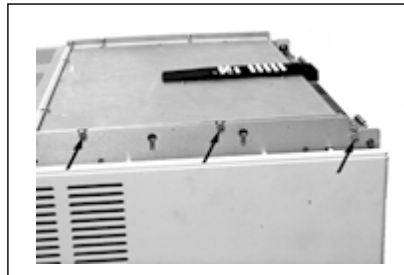

Horizontal Scan Switches

Three switches are used, one for each CRT. When changing the horizontal scan, insure that all three switches are set in the same position. See positions of the switches (diagram on next page) for the corresponding projector configuration.

To set the scan switches :

- Remove the horizontal deflection module (the second module viewing from the rear of the projector).

To remove the horizontal deflection module :

- Press the module lock and lift up the module handle;

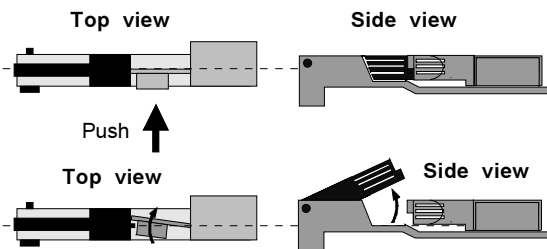

- Repeat this action on both sides of the module and extract the module out of the main frame.

- Toggle the 3 horizontal scan inversion switches (located just underneath the horizontal amplitude module) to the correct positions (see p.4-3).
- Reinstall the horizontal deflection module.

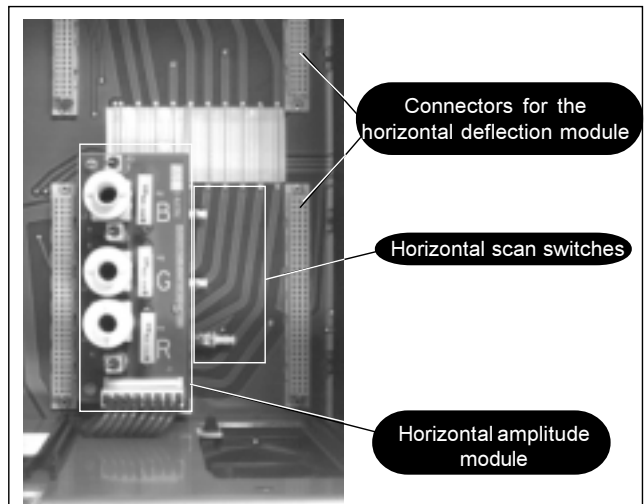
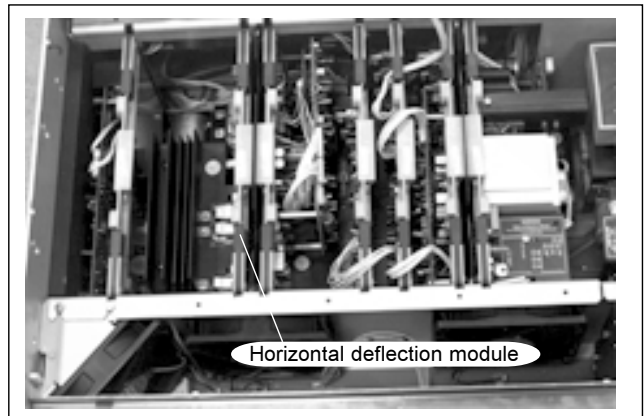

Vertical Scan Switch

One vertical switch is used for the three CRT's. See position of the switch (diagrams) for the corresponding projector configuration.

To set the vertical scan switch :

- Remove the vertical deflection module (the third module viewing from the rear of the projector).

To remove the vertical deflection module :

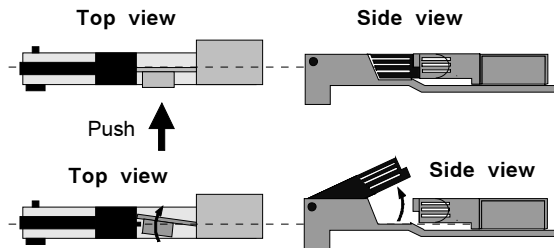

- Press the module lock and lift up the module handle;
- Repeat this action on both sides of the module and extract the module out of the main frame.

- Toggle the vertical scan inversion switch to the correct position.
- Reinstall the vertical deflection module.

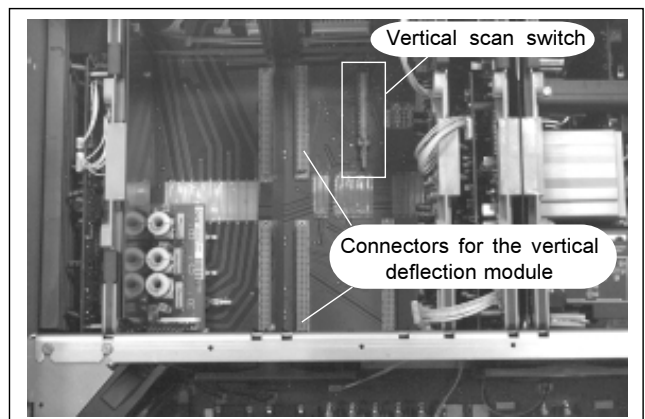
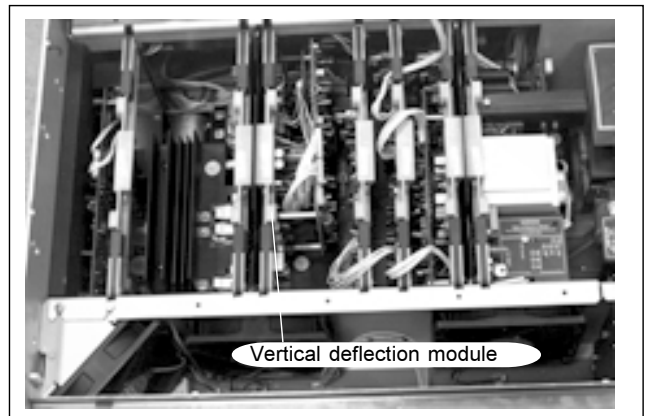

Positions of the scan switches for the different mounting configurations are illustrated on the right side.

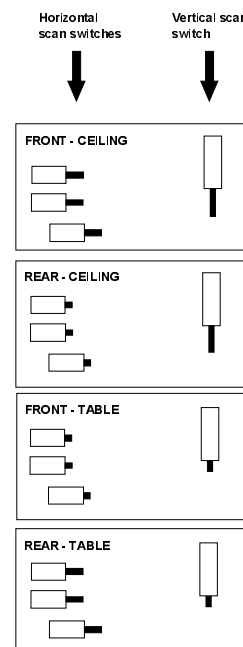

After setting the scan switches, close the metal protection plate and secure it with the retaining screws.

Close the top cover and reconnect the power cord to the wall outlet.

Note : Switching over from Floor to Ceiling or vice versa requires a complete readjustment of picture geometry and convergence.

To check the current positions of the scan switches, proceed as follows:

Attention : This procedure can only be done after power (mains) connection. So, first continue with the projector setup and the connections and then return to this procedure.

- Switch on the projector. The projector starts up on the last selected source.
- Press the <ADJUST> key.
- Highlight 'SERVICE' by pushing the control stick forward or backward and press the <ENTER> key: the 'SERVICE MODE MENU' will be displayed.
- Highlight 'IDENTIFICATION' by pushing the control stick forward or backward and press the <ENTER> key.

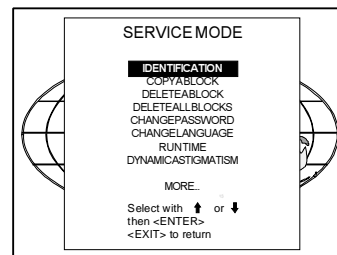
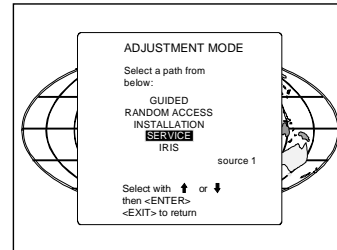

The projector will display the 'IDENTIFICATION SCREEN'.

This screen gives the current information about the projector configuration in the line entitled 'Config'.

All projectors leave the factory set for a ceiling/front configuration.



5

PROJECTOR SETUP

The DIP switches on the controller board allow the *SETUP* of the projector :

- 8 DIP switches for setting the projector address.
- 1 DIP switch for setting the powerup mode.
- 3 DIP switches for setting the baud rate for communication.
- 1 DIP switch for setting the password mode.

To gain access to the DIP switches :

- Open the top cover.
- Loosen the retaining screws of the metal protection plate and pivot this plate to the lens side (Please refer to Chapter 4 'Installation setup').

The DIP switches are located on the back side of this metal protection plate.

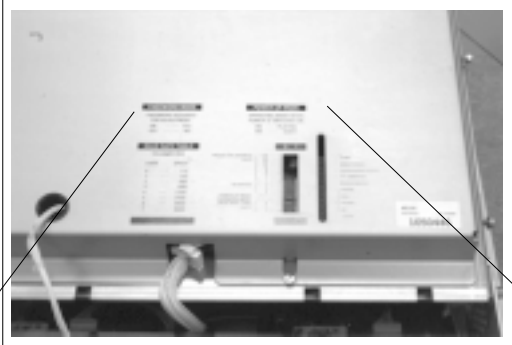

PASSWORD MODE		POWER UP MODE	
PASSWORD REQUIRED FOR ADJUSTMENT		OPERATING MODE WHEN POWER IS SWITCHED ON	
ON	YES	ON	PLAYING
OFF	NO	OFF	StdBY

BAUD RATE TABLE		0 1	
TO COMPUTER		PROJECTOR ADDRESS (sum)	
CODE	SPEED	128	1
0	110	64	1
1	150	32	1
2	300	16	1
3	600	8	1
4	1200	4	1
5	2400	2	1
6	4800	1	1
7	9600	RESERVED	1
		POWER UP MODE	1
		PASSWORD MOD	1
		BAUD RATE CODE (sum)	1
		2	1
		1	1

—	StdBY
—	MAIN POWER
—	PROCESS CYCLE
—	PC SHORTED
—	BLOCK MATCH
—	ERROR
—	RCU
—	RCVDS
—	PC
—	PAUSE

Setting the projector address

The projector's address may be set to any value between 0 and 255.

When the address is set, the projector can be controlled now by :

- RCU for addresses between 0 and 9.
- IBM PC (or compatible) or Apple MAC for addresses between 0 and 255.

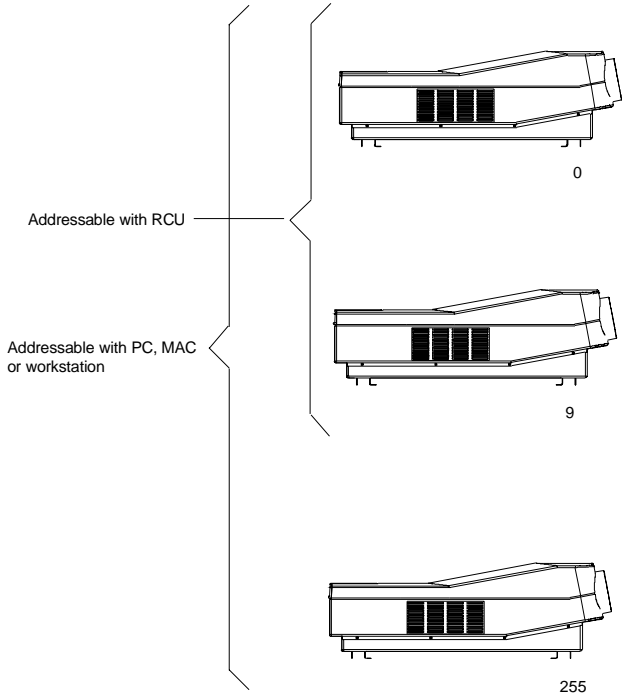

Projector setup

Setting the address is a hardware SETUP of your projector which must be done during installation. Use the 8 DIP switches provided on the controller board labelled 'Projector Address'.

Each DIP switch has its own decimal value. The sum of the values associated to those DIP switches gives the address. As shown in the table, if Switch No. 1 is set to ON, it represents a decimal value of 128, Switch No.2 for 64, Switch No.3 for 32, and so forth.

In the given example, the projector address is set to 202 :

DIP switch No. : 1 2 3 4 5 6 7 8
 Position ON/OFF : 1 1 0 0 1 0 1 0

Sum : $1 \times 128 + 1 \times 64 + 0 \times 32 + 0 \times 16 + 1 \times 8 + 0 \times 4 + 1 \times 2 + 0 \times 1 = 202$

Factory preset address = 0

Note :

When the address button on the RCU is pressed, the projector will display its own address on the screen. Once the address button is pressed, to continue using your RCU, it is necessary to enter an address, even when the displayed address is correct. Use the numeric keys to enter the address.

For more information, please refer to the projector Owner's Manual .

Switch No	Value
1	128
2	64
3	32
4	16
5	8
6	4
7	2
8	1

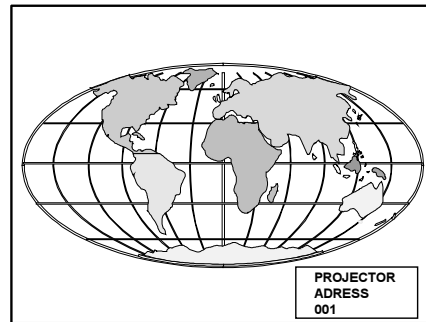
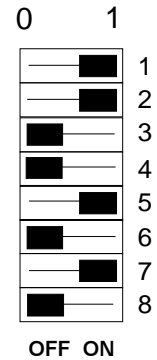

Powerup mode

The projector can start up in two different modes. The start-up mode is determined by the position of DIP Switch No. 4 of another set of 8 DIP switches on the controller board (one set of 8 switches are used for projector address setting).

Position of the DIP Switch No. 4 (powerup mode) :

- ON : operational mode.
- OFF : standby mode (Factory preset).

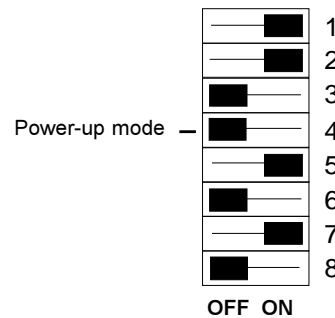

• Operational mode

When the power switch on the rear of the projector is pressed, the projector displays the last selected source if available, otherwise it remains on that source number until the source becomes available.

The on screen indication is only available when the "Text" function is set to "ON".

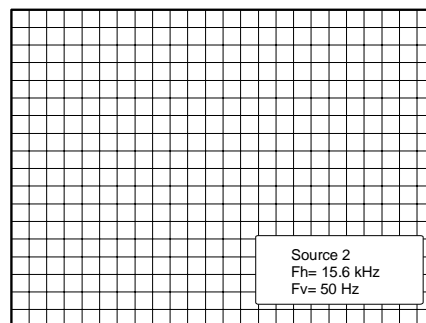

• Standby mode

When the power switch on the rear of the projector is pressed, the projector starts up in the standby mode. The standby key on the RCU is used to turn the projector ON and OFF.

Baud Rate for communication with a computer

The communication speed between the projector and the computer has 8 possible settings. With DIP Switch No. 6, No.7 and No.8 of the 8 DIP switches on the controller board, labelled as 'Baud rate code (sum)', it is possible to select the baud rate (communication speed). Each DIP switch has its own decimal value. The sum of the values associated to those DIP switches gives the baud rate code. Each baud rate code corresponds an communication speed.

Position of DIP switches and baud rate codes :

Binary	Baud rate code	Speed
000	0	110
001	1	150
010	2	300
011	3	600
100	4	1200
101	5	2400
110	6	4800
111	7	9600

Factory preset baud rate = 9600

More information about computer communication with the BARCOGRAPHICS 808s is available in the Projector Control Software manual.

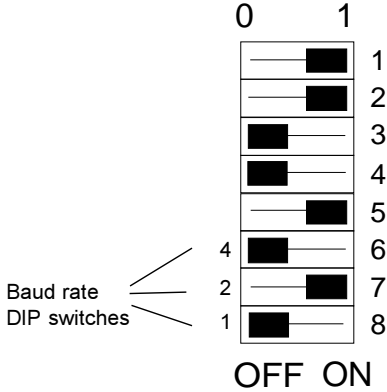

Password mode

With DIP Switch No.5 of the second set of 8 DIP switches on the controller board, the projector adjustments can be protected with a password. When the password feature is enabled, the user has to enter a password before he can enter the adjustment mode (For more information about password setting and reprogramming the password, see Installation Adjustment).

When the password menus are disabled (adjust mode is unprotected), the adjust mode can be selected by pressing the <ADJUST> key. This position of the DIP switch is useful for qualified service technicians because they do not need a password to enter the adjust mode.

Position of DIP Switch No.5 :

- ON : password mode enabled.
- OFF : password mode disabled.

Factory preset password mode : OFF.



6

AC POWER CONNECTION

AC Power (mains) cord connection

Use the supplied cord to connect your projector to the wall outlet. Plug the female power connector into the male connector at the back of the projector.

This projector may be connected to an IT-power system. The IT-power system is a power distribution system having no direct connection to earth. Instead, the exposed conductive parts of the electrical installation are earthed.

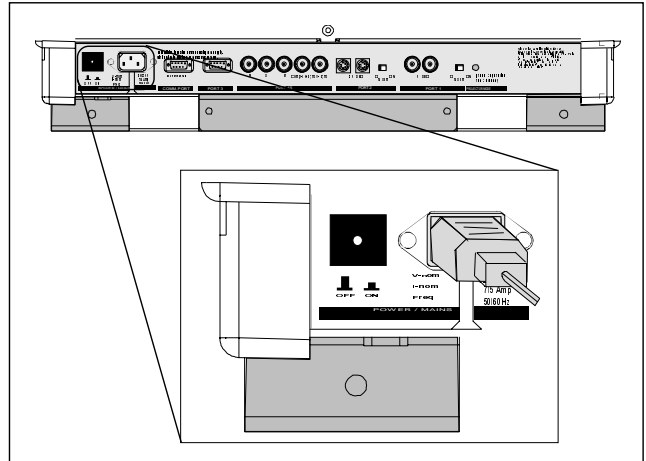

Preparing your power cord

Mains lead (power cord) with CEE7 plug

As the colors of the wires in the mains lead of this apparatus may not correspond with the colored markings identifying the terminals in your plug, proceed as follows:

- The yellow/green wire is ground and must be connected to the terminal in the plug which is marked by the letter E or by the safety earth symbol \perp or colored yellow and green.
- The blue wire is neutral and must be connected to the terminal marked with the letter N or colored black.
- The brown wire is the line and must be connected to the terminal marked with the letter L or colored red.

The wires of the delivered mains lead (power cord) are colored in accordance with the following code :

Yellow and Green	:	Ground (Earth).
Blue	:	Neutral.
Brown	:	Live.

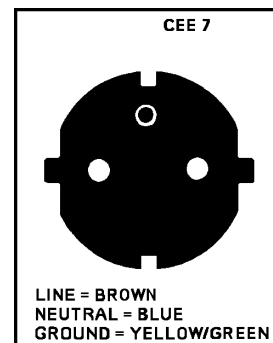

Power cord with an ANSI 73.11 plug

The wires of the delivered mains lead (power cord) are colored in accordance with the following code :

Yellow and Green	:	Ground (Earth).
White	:	Neutral.
Black	:	Live.

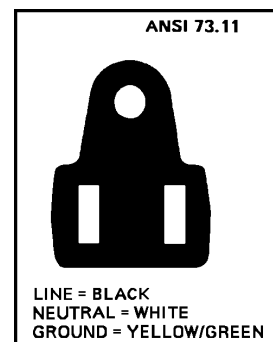

AC Power check

Check the power voltage which is determined by the ART. NR. (Article number) included in the label pasted on the backside of the projector.

Projectors with the ART. NR. R9000901 and R9000902 must be connected to a 230 VAC power source.

Projectors with the ART. NR. R9000908 and R9000907 must be connected to a 120 VAC power source.

If the indicated voltage is different from that of the wall outlet, call a qualified technician for power adaptation of the projector.

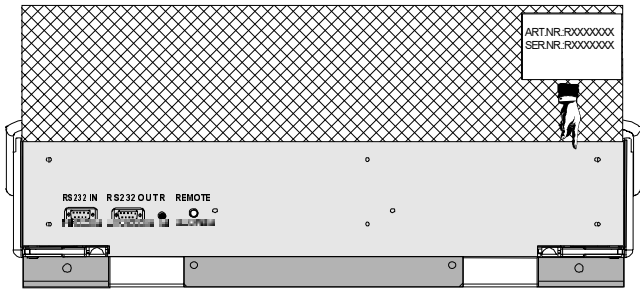

AC Input power (mains) voltage adaptation

Attention !

The BARCOGRAPHICS 808s - R9000901 and R9000902 leave the factory to operate on a mains (power) input of 230 Vac.

The BARCOGRAPHICS 808s - R9000908 and R9000907 leave the factory to operate on a mains (power) input of 120 Vac.

Adaptation of the power input of the projector between 230 Vac and 120Vac or vice versa is possible.

Follow the procedure as described below to adapt the voltage :

- **WARNING: turn off the projector and be sure the AC Power Cord is unplugged before starting the procedure !**
- Open the top cover (see 'Access to controls' on p.4-1).
- Unscrew the retaining screws of the AC power input board and remove this board.

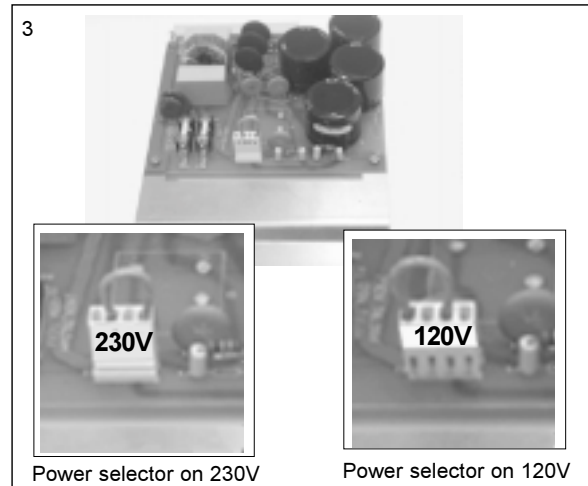
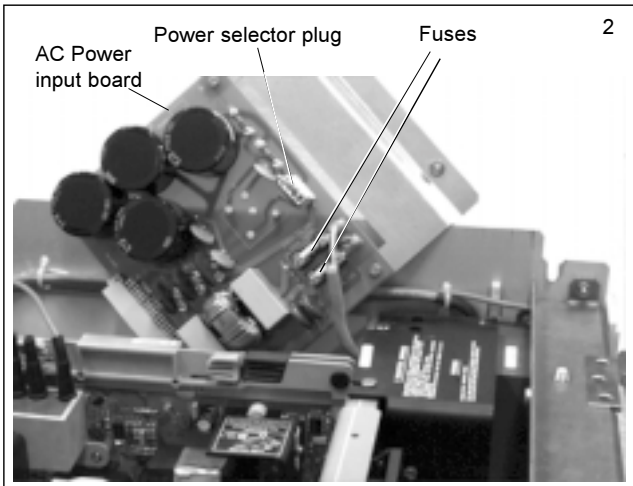
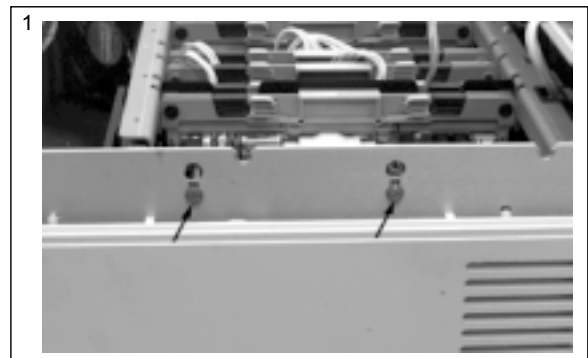

- Pull out the 'Power selector plug' (Photo 2) and reinsert it as illustrated in Photo 3, depending on the AC power of the wall outlet in the room.
- Pull out the fuses and place the correct fuses in their sockets. See the table below for the correct type of fuses.
- Reinsert the power input board and secure it with the retaining screws.

Fuses

Warning !

For continued protection against fire hazard :

- Replace with the same type of fuse.
- Refer replacement to qualified service personnel.

AC power	Fuses	Order Number
230 Vac	T6.3A/250V (2x)	R314145
120 Vac	T10A/250V (2x)	R314154

Switching on the projector

Push the power (mains) switch located on the rear panel of the projector to switch the projector ON and OFF :

- If the switch is pressed in : ON
- If the switch is Not pressed in : OFF

The projector can be started up in the 'Operational mode' (image displayed) or in the 'Standby mode', depending on the position of the 'Powerup' DIP switch on the controller board (see p.5-2). This DIP switch is set during installation by a qualified technician. If you want to change this start-up mode, call a qualified technician.

Power indication lamp :

- OFF : no power.
- Green : projector in operational mode.
- Red : projector in standby mode.

When switching on the projector, with the power switch or via the standby key on the RCU, the projector can start up in two ways if the "CRT run in cycle" option is switched OFF :

- A full white image (projector warm up) or
- Immediately image display.

The way of starting up can be set in the service mode.

Starting up with a full white image

When the projector is set to start up with a full white image, the "Projector warm up" menu will be displayed for 30 seconds.

Start up with "Warm up period"

If no action is taken, a white image will be displayed for 20 minutes. This white image will be shifted on the faceplate of the CRT to avoid CRT burn-in.

During this warm up period, it is possible to interrupt this white image projection by pressing the <EXIT> key. The "Projector warm up" menu will be redisplayed for another 30 seconds but with the remaining time indicated.

If the <EXIT> key is pressed again, the remaining warm up period will be skipped.

During the warm up period, every 30 seconds a text box with the remaining time will be displayed on the screen for 2 seconds. This text box will be displayed every time on another place to avoid CRT burn-in.

If a key, other than the <EXIT> key, is pressed, a text box with the following text will be displayed :

"Please use <EXIT> to leave this procedure."

Start up without "Warm up period"

If the <EXIT> key is pressed, the warm up period will be skipped and the projector is immediately ready for use.

Warning : Skipping this warm up procedure can reduce the initial picture quality of the projected image.

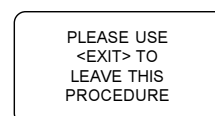
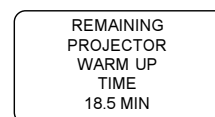
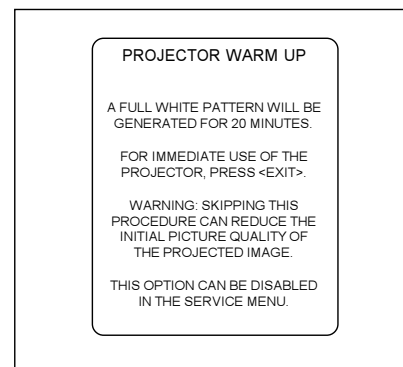
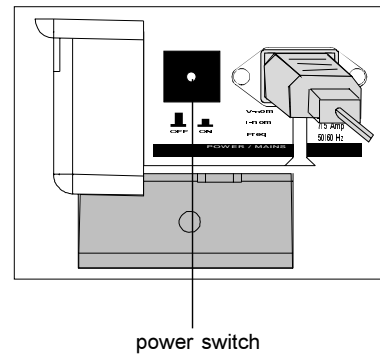

7

SOURCE CONNECTIONS

Signal input connection

The following signals can be connected to the projector through the inputs on the back panel of the projector :

- Composite Video
- S-Video
- RGB
- Component Video
- RGB with Tri-level sync
- Component video with Tri-level sync

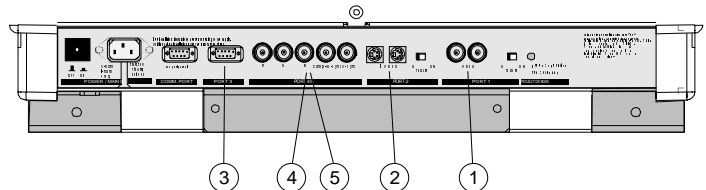

Port No	Projector input	Numeric button	Description of input signal
1	Composite Video	1	
2	S-Video / Composite Video	2	S-video : Y/C (luma/chroma). The Composite video can also be connected to Port 2. It can be selected inside the "Picture Tuning" menu. Please refer to the Owner's Manual of this projector.
3	RGB	3	R, G and B with composite sync on Green; R, G and B with separate composite or with separate Horizontal and Vertical sync.
4/5	RGB	4 or 5	R, G and B with composite sync on Green; R, G and B with separate composite or with separate Horizontal and Vertical sync.
4/5	Component video	6	R-Y, Y, B-Y with composite sync on Y; or with separate composite or with separate Horizontal and Vertical sync.
4/5	RGB with Tri-level sync	7	R, G and B with Tri-level sync on Green; R, G and B with separate Tri-level sync or with separate Horizontal and Vertical Tri-level sync.
4/5	Component video with Tri-level sync	8	R-Y, Y, B-Y with Tri-level sync on Y; or with separate Tri-level sync or with separate Horizontal and Vertical Tri-level sync.

Only available when the optional Tri-level sync module is installed.

Connecting a Composite Video source to Port 1

Composite video signals coming from a VCR, OFF air signal decoder and so on can be connected to Port 1.

To select the video input :

Press the *numeric button 1* on the RCU or the local keypad.

75 W Termination Switch for Video

Terminate the video input of the projector using the 75W switch next to the video input, when the projector operates alone or when the projector is the last unit in a loop-through configuration.

The switch is set to "ON" : signal terminated.
The switch is set to "OFF" : signal not terminated.

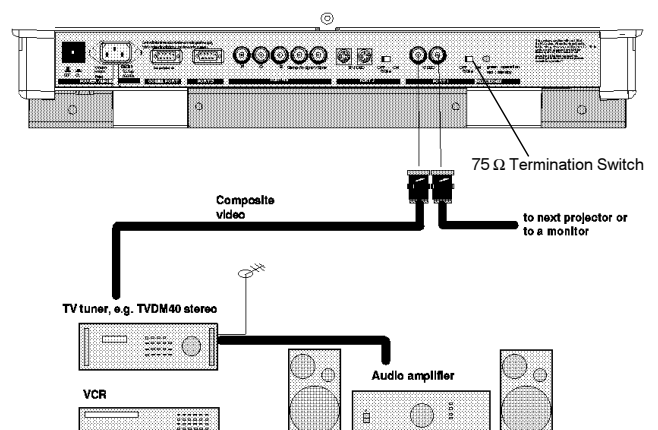

Connecting a S-Video (or Composite Video) source to Port 2

Separate Y-luma/C-chroma signals for higher quality playback of Super VHS signals can be connected to Port 2. The composite video can also be connected to this port.

To select the S-video input :

Press the *numeric button 2* on the RCU or the local keypad.

In case of using Port 2 for connecting the Composite Video, the selection of this source have to be done inside the "Picture Tuning" menu. Please refer to the Owner's Manual of this projector.

75 W Termination Switch for S-video

Terminate the S-video input of the projector using the 75 W switch next to the S-video input when the projector operates alone or when the projector is the last unit in a loop-through configuration.

The switch is set to "ON" : signal terminated.
The switch is set to "OFF" : signal not terminated.

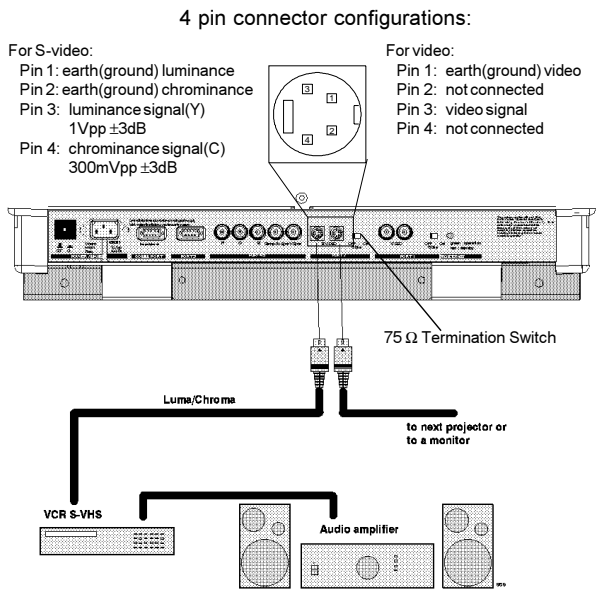

Connecting a RGB Analog source to Port 3

Connect a RGB Analog signal via an interface (e.g. RGB 120MHz interface, part number 98 26570) to Port 3: RGB analog input with automatic sync detection (Separate H and V sync inputs, with composite sync input or with sync signals on green).

Pin configuration of the D9 (male) connector of the Analog input :

- 1 not connected
- 2 ground RGBS
- 3 RED
- 4 GREEN
- 5 BLUE
- 6 ground RGBS
- 7 ground RGBS
- 8 Horizontal /composite sync
- 9 Vertical sync

To select the RGB analog Input :

Press the *numeric button 3* on the RCU or the local keypad.

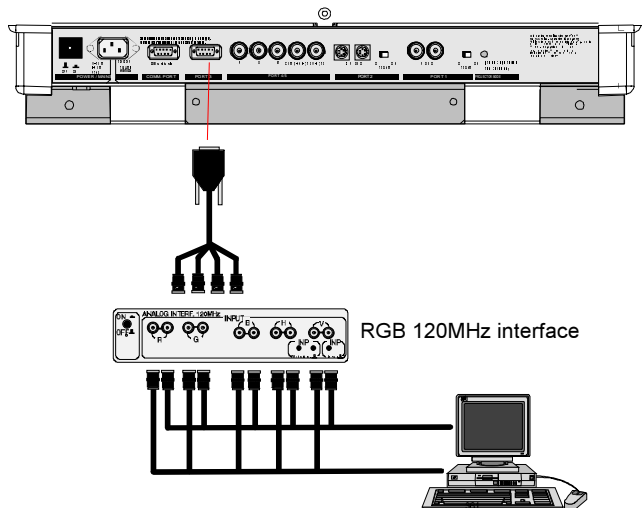

Locations of the Termination Resistors and Switches on the RGB Input Auto Sync Tracking Module

When changing a switch position or removing a resistor, turn off the projector and unplug the power cord from the wall outlet.

75 W Termination resistors

In case of chaining (loop-through) the projectors, the 75W line termination resistors must be removed from the RGB Input Auto Sync Tracking Module when the projector is **NOT** the last unit in the chain. In case of a stand-alone projector, do not remove the resistors.

75 W resistors on the module : line terminated.
75 W resistors removed : line not terminated.

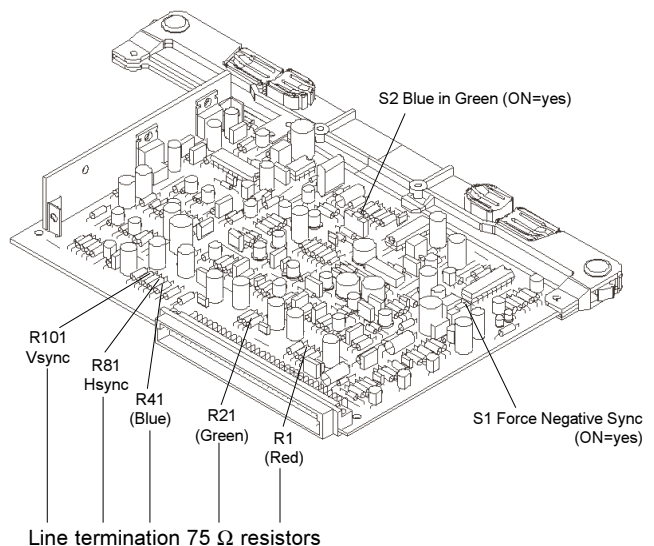

Procedure to remove the line termination resistors :

- Turn off the projector and unplug the projector power cord.
- Remove the top cover from the projector (see p.4-1).
- Remove the RGB Input Auto Sync Tracking Module from the main frame.
- Unsolder and remove the resistors.

To remove the RGB Input Auto Sync Tracking Module, follow the same procedure as described in p.4-2 for removing the Horizontal Deflection module :

- Press the module lock and lift up the module handle;
- Repeat this action on both sides of the module and extract the module out of the main frame.

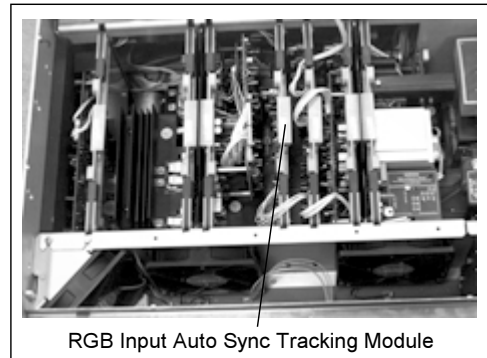
**Blue in Green Switch on the RGB Input Auto Sync Tracking Module**

Blue characters are difficult to read, therefore the blue text will be displayed as cyan so that the readability becomes better.

Switch in the ON position : Blue in Green active.

Switch in the OFF position : Blue in Green disabled.

WARNING : Leaving the switch in the ON position will result in abnormal color balance of the projected image.

Force Negative Sync on the RGB Input Auto Sync Tracking Module

Switch in the ON position : the sync pulses must be negative.

Switch in the OFF position : the sync polarity will be automatically detected.

Connecting a RGB Analog source to Port 4/5

RGB analog input terminals with separate H and V sync inputs, composite sync input or sync signals on green can be connected to the projector via Port 4/5. The projector automatically detects where the sync signal is located.

An interface is recommended when connecting a computer and local monitor to the projector. BARCO provides the following interfaces :

- Universal Analog Interface - Order number : R9826100.
- RGB 120 MHz Analog Interface - Order number : R9826570.

To select the RGB input :

Press the *numeric button 4 or 5* on the RCU or the local keypad.

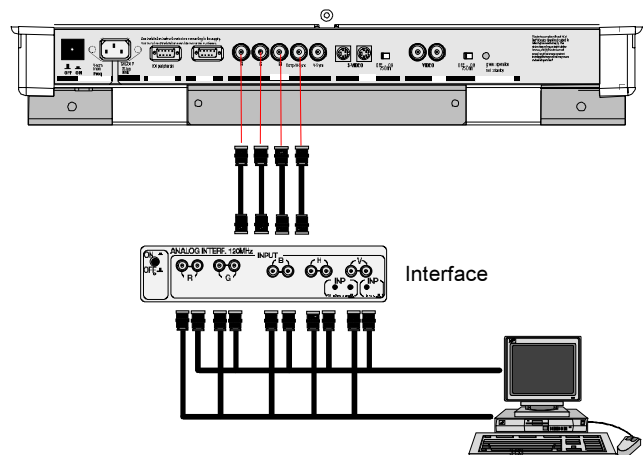
**Connecting a Component Video source to Port 4/5**

A component video (R-Y, Y, B-Y) with sync signals can be connected to the projector via Port 4/5. The projector automatically detects where the sync signal is located.

An HDTV interface is recommended when connecting a computer and local monitor to the projector. The HDTV Kit Order number : R9828040.

To select the component video input :

Press the *numeric button 6* on the RCU or the local keypad.

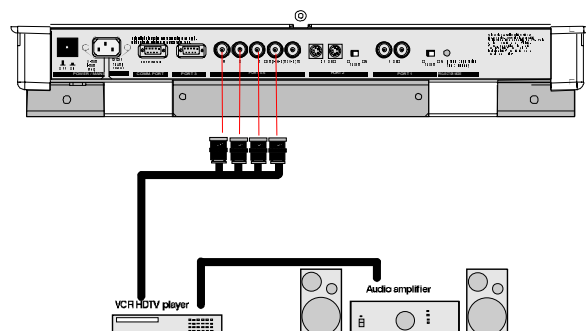

Connecting a RGB Analog source with Tri-level sync to Port 4/5 (option)

RGB analog input terminals with Tri-level sync input or with Tri-level sync on green can be connected to the projector via Port 4/5. The projector detects automatically where the sync signal is located. This feature requires an optional Tri-Level Sync Module - Order Number R9828040.

To select the input :

Press the *numeric button 7* on the RCU or the local keypad.

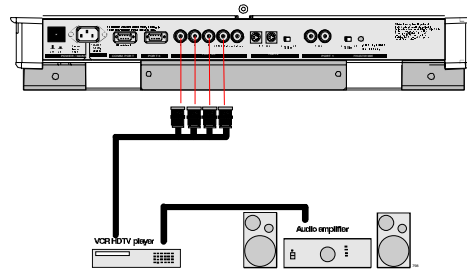

Connecting a Component Video source with Tri-level sync to Port 4/5 (option)

Component video inputs with Tri-level sync signal can be connected to the projector via Port 4/5. The projector detects automatically where the sync signal is located. This feature requires an optional Tri-Level Sync Module - Order Number R9828040.

To select the input :

Press the *numeric button 8* on the RCU or the local keypad.

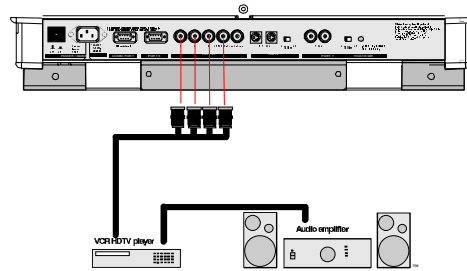

Peripheral equipment

Connecting a RCVDS 05 source selector to the BARCOGRAPHICS 808s

- Up to 20 inputs with a RCVDS05 and up to 90 inputs can be accommodated when multiple RCVDS source selectors are linked via a Expansion Module.
- Serial communication with the projector.
- Remote control buttons on the RCVDS05 to control the BARCOGRAPHICS 808s (source selection and analog settings).
- The selected source number will be displayed on a 2-digit display and the selected input modules will be indicated with a LED on the rear.

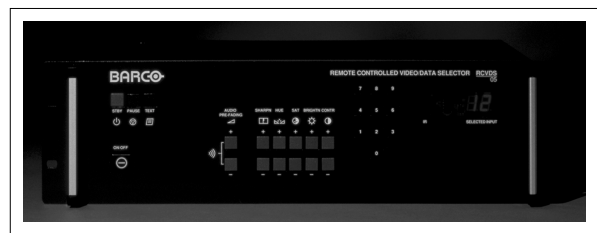

The order numbers for the RCVDS05 source selector :

RCVDS05 230 V	R9827880
RCVDS05 120 V	R9827889

For more information about the use of the RCVDS05, consult the RCVDS05 Owner's Manual - order number : R5975765.

Connecting a VS05 source selector to the BARCOGRAPHICS 808s

The VS05 can switch up to 5 Composite Video sources, 3 S-Video Sources and 1 RGB analog or component Video source to the BARCOGRAPHICS 808s. In addition, the audio signal associated with the source, can be switched to an audio amplifier.

VS05 order number : R9827890.

For more information about the use of the VS05, consult the VS05 Owner's Manual - order number : R5975245.



Connecting an IR Remote Receiver 800 to the BARCOGRAPHICS 808s

This infrared Remote Receiver makes it possible to control the BARCOGRAPHICS 808s from another room. There is a communication cable between the IR Remote Receiver and the projector. The control information from the RCU can now be sent to the IR Remote Receiver 800. The IR Remote Receiver 800 displays the selected source on a 7-segment display.

IR Remote Receiver 800 order number : R9827515.

8

INSTALLATION ADJUSTMENT MODE

Access to Installation Adjustment Mode

It will be necessary to perform several mechanical adjustments while in the Installation Adjustment Mode. It will be required to open and remove the projector's top cover in order to gain access to the adjustment points.

To enter into the installation adjustment mode :

- Press the <ADJUST> key to start up the adjustment mode.
- Push the control stick forward or backward to highlight the path *INSTALLATION* in the "Adjustment mode" menu and then press the <ENTER> key.
- A warning will be displayed on the screen. If you are a qualified and authorized service person, press the <ENTER> key to start up the installation mode. Otherwise, press the <EXIT> key to return.
- When entering the installation mode, the projector will automatically switch to the internal pattern on 15 kHz/50 Hz.
- When the password mode is active (see p.5-3), you will be requested to enter the 4 digit password.

Enter the digits with the numeric keys on the RCU or the local keypad.

Example : Password as 2 3 1 9

For each digit entered, a 'X' appears on the screen under the displayed text 'enter password'.

If the entered password is correct, you get access to the 'Installation Adjustment Mode'.

If the entered password is wrong, The message "*Wrong password!!!!*" will be displayed. The projector stays on the previous selected item.

Factory programmed password :

0 0 0 0

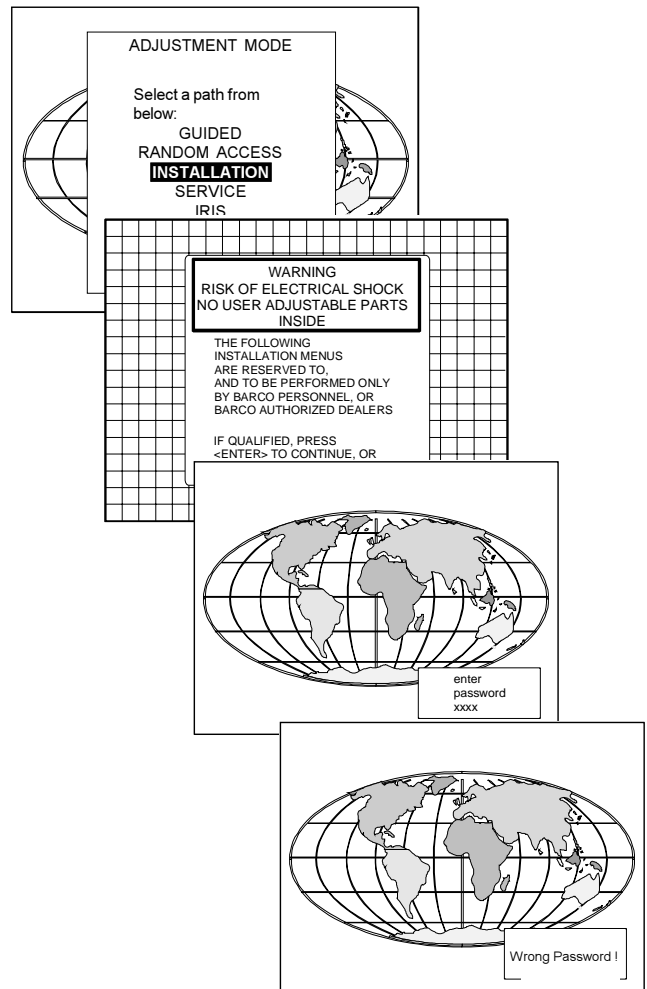

Overview flowchart of the Installation Adjustment Mode

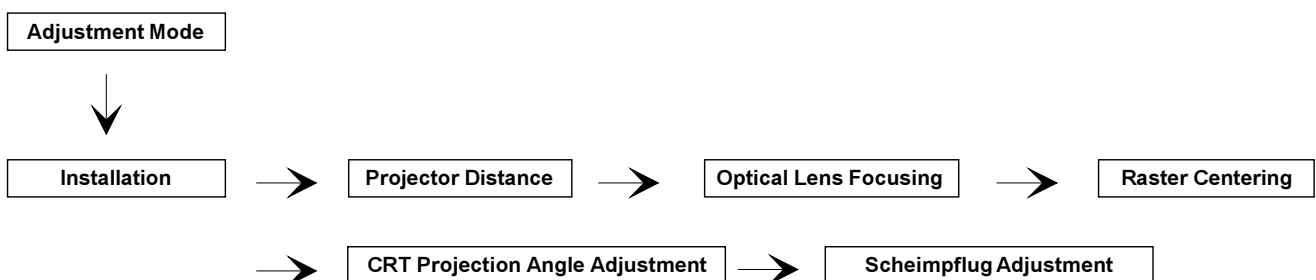

Important : Access to adjustments

The top cover of the projector should be removed in order to gain access to the adjustments.
Please refer to p.4-1 for how to remove the top cover.

Projector Distance

On the screen, a drawing will be displayed together with parameters indicating a correct installation position.

To change the screen width :

- Push the control stick to the left or to the right to highlight the item **SW** in the "Projector Distance 1" menu and then press the **<TEXT>** key.
- If the **<ENTER>** key is pressed, the "Optical Lens Focusing" will be displayed.
- If the **<EXIT>** key is pressed, the projector will return to the previous menu.
- After the **<TEXT>** key is pressed, the next menu "Projector Distance 2" will be displayed on the screen. It allows the user to change the Screen width.
- Push the control stick to the left or to the right to highlight the digit needed to be changed, and enter the desired digit with the numeric keys on the RCU or the local keypad.
- Press the **<ENTER>** key to confirm the changes. The projector will redisplay the "Projector Distance 1" menu with updated values for the three parameters.
- Press the **<ENTER>** key to continue with the "Optical Lens Focusing".
If the **<EXIT>** key is pressed, the projector will return to the previous menu.

The same applies to the PD (projector distance). You can use the above-mentioned procedure to obtain a correct updated value of SW (screenwidth) after entering a new value of PD (projector distance).

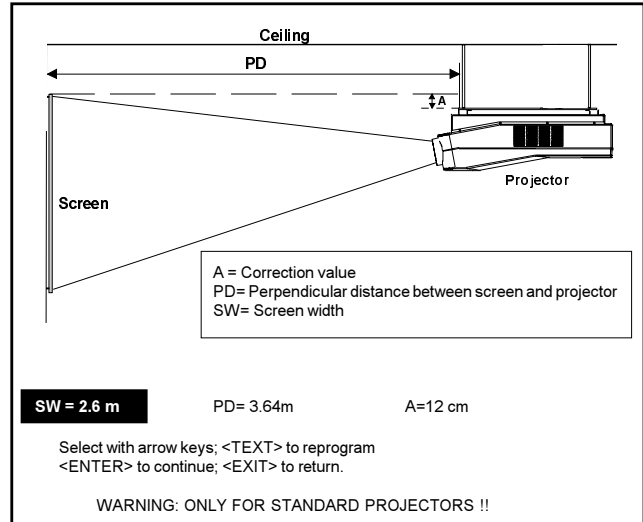

SCREENWIDTH = **2**, 6 0 m

Select with arrow keys; reprogram with numeric keys and then **<ENTER>** to confirm.
Maximum screenwidth = 6 m
Maximum proj. distance = 8,1 m.

Optical Lens Focusing

The optical focusing procedure is performed separately for each lens. The appropriate CRT will be switched on as the user proceeds through the optical focusing adjustment sequence.

Each lens has two focus adjustment points, one at the rear of the lens and one at the front. The center of the projected image is focused by loosening the wing nut at the rear end of the lens and rotating the lens barrel until the center of the image is clearly focused. The corners of the projected image are focused by loosening the wing nut at the front end of the lens and rotating the lens barrel until the corners of the image are clearly focused. Repetition of these adjustments may be necessary to optimize optical focusing.

Press the **<ENTER>** key to continue. After finishing focusing of the three lenses, press the **<ENTER>** key to enter the Raster centering. Press the **<EXIT>** key to return to operational mode. Press the **<ADJUST>** key to return to operational mode.

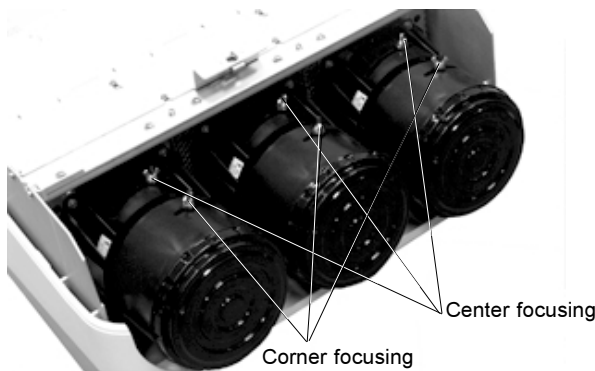

OPTICAL LENS FOCUSING

1. LOOSEN THE NUT ON THE REAR OF THE GREEN LENS, ROTATE THE LENS BARREL TO FOCUS THE CENTER OF THE IMAGE, THEN TIGHTEN THE NUT

2. LOOSEN THE NUT ON THE FRONT OF THE GREEN LENS AND ROTATE THE FRONT SECTION OF THE LENS TO FOCUS THE CORNERS OF THE IMAGE, THEN TIGHTEN THE NUT.

OPTICAL LENS FOCUSING

1. LOOSEN THE NUT ON THE REAR OF THE RED LENS, ROTATE THE LENS BARREL TO FOCUS THE CENTER OF THE IMAGE, THEN TIGHTEN THE NUT

2. LOOSEN THE NUT ON THE FRONT OF THE RED LENS AND ROTATE THE FRONT SECTION OF THE LENS TO FOCUS THE CORNERS OF THE IMAGE, THEN TIGHTEN THE NUT.

OPTICAL LENS FOCUSING

1. LOOSEN THE NUT ON THE REAR OF THE BLUE LENS, ROTATE THE LENS BARREL TO FOCUS THE CENTER OF THE IMAGE, THEN TIGHTEN THE NUT

2. LOOSEN THE NUT ON THE FRONT OF THE BLUE LENS AND ROTATE THE FRONT SECTION OF THE LENS TO FOCUS THE CORNERS OF THE IMAGE, THEN TIGHTEN THE NUT.

<ENTER> to continue
<EXIT> to return

Raster Centering

The raster must be centered on the CRT faceplate of each tube, therefore, it is necessary to look into the lenses.

Caution : To avoid eye discomfort while performing these adjustments, reduce the contrast and gradually increase the brightness level until the raster becomes visible behind the image.

Warning : In order to ensure maximum CRT longevity and to avoid CRT damage, do not shift the raster outside the phosphor area of the CRT.

Press the <ENTER> key to display the raster on the green CRT.

Look into the green lens and shift the raster with the control stick until it is centered in the middle of the CRT faceplate.

Press the <ENTER> key to activate the raster on the Red CRT faceplate.

Shift the Red raster with the control stick until the raster is centered on the CRT faceplate.

Press the <ENTER> key to activate the raster on the Blue CRT faceplate.

Shift the Blue raster with the joy stick until the raster is centered on the CRT faceplate.

Press the <ENTER> key to continue with the CRT projection angle adjustment.

Press the <EXIT> key to return to Optical focusing.

Press the <ADJUST> key to return to Operational mode.

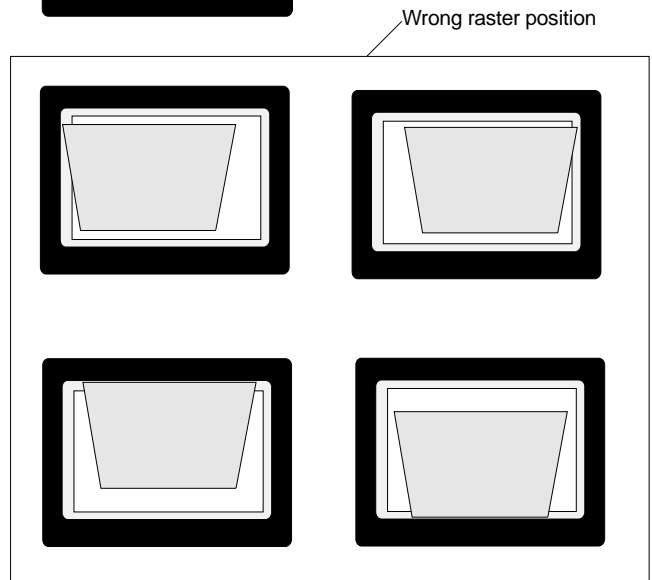
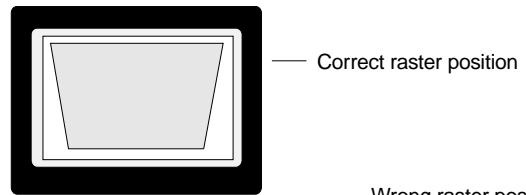
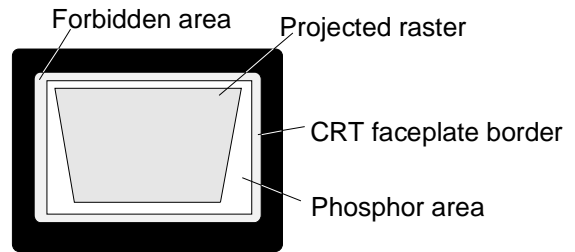
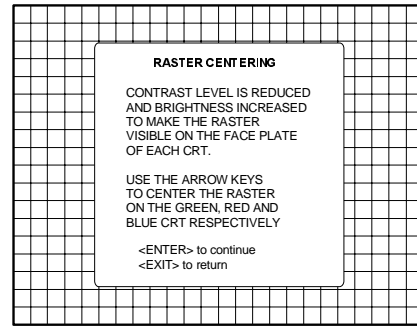

CRT Projection Angle Adjustment

The projection angle of the red and blue CRT's is dependent on the desired size of the projected image. If the centers of green, blue and red do not coincide, the CRT projection angle must be adjusted.

NOTE : Never try to correct this misalignment with the shift correction or the static convergence controls. These controls may only be applied to correct small errors which cannot be corrected by the CRT angle adjustment.

Note: The Horizontal Shift and Vertical Shift for Red and Blue should be set near 50%.

Be sure that the rasters are centered on the CRT faceplate.

Press the <ENTER> key to start the CRT angle adjustment procedure.

Press the <ENTER> key to continue with the second part of the CRT projection angle adjustment.

Press the <ENTER> key to continue with the crosshairs alignment. Press the <EXIT> key to return to the previous menu.

Press the <ADJUST> key to return to Operational mode.

Loosen bolts A, B, C and D to pivot the red CRT until the center of the Red image and the center of the Green image coincide. When the angle of the red CRT is corrected, tighten the four bolts.

Press the <ENTER> key to continue with blue and green crosshairs. Press the <EXIT> key to return to the CRT projection angle adjustment menu.

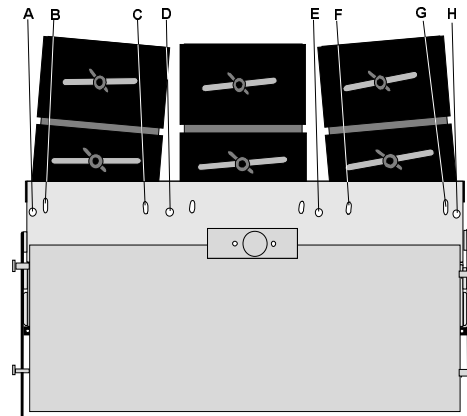
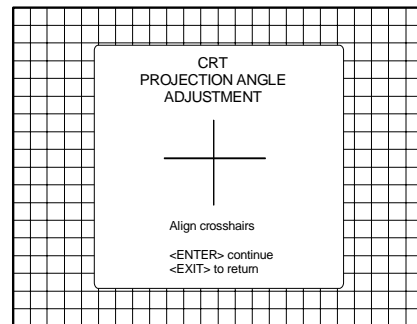
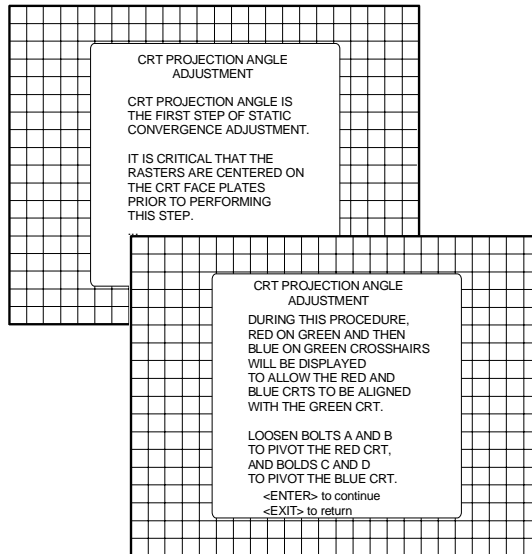
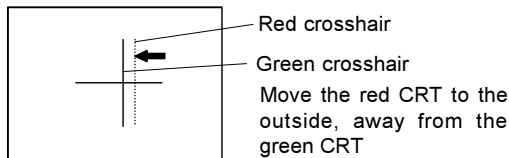
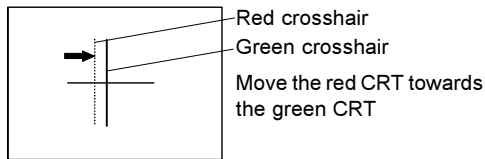

Loosen bolts E, F, G and H to pivot the blue CRT until the center of the Blue image and the center of the Green image coincide. When the angle of the blue CRT is corrected, tighten the four bolts. Press the <ENTER> key to continue with the diagonal focusing menu. Press the <EXIT> key to return to the CRT projection angle adjustment.

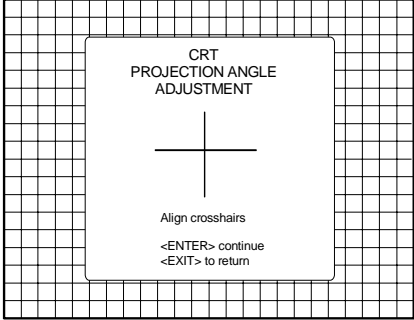
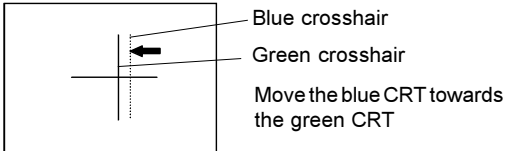
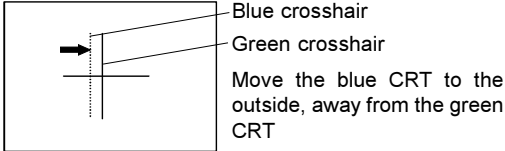

Projection angle correctly aligned for screen width SW1.

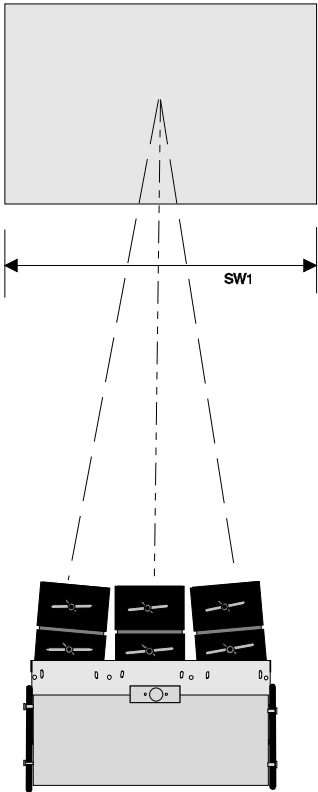

The same projection angle is misaligned for new screen width SW2. Realignment is necessary. Each screen width change requires readjustment of the projection angle.

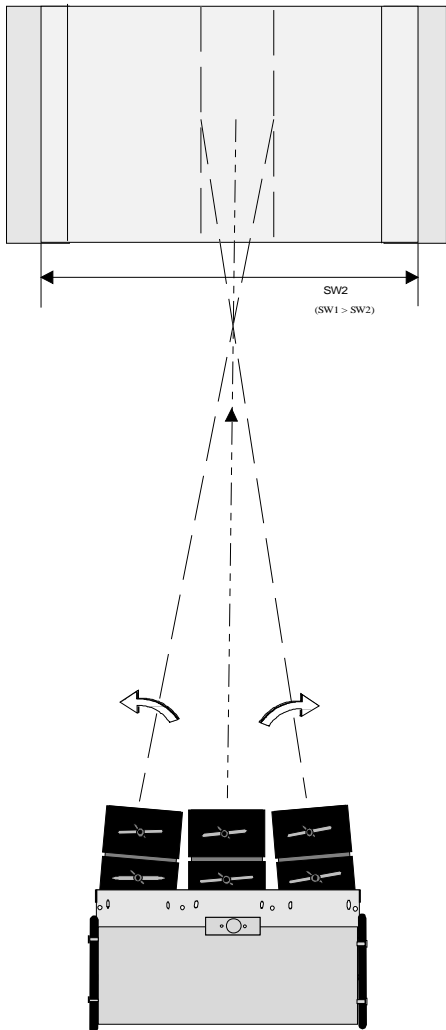

Scheimpflug Adjustment (Diagonal image focusing)

With the diagonal image focusing corrections, it is possible to obtain uniform focus for the total projected image.

These corrections must be repeated for each color. The Diagonal image focusing is repeated 3 times, first for green, then for red and then for blue.

First, be sure that the CRT projection angle is correctly adjusted, otherwise it is not possible to obtain proper overall focus of the image.

Press the <ENTER> key to start the green adjustment.
Press the <EXIT> key to return to CRT Projection Angle Adjustment.
Press the <ADJUST> key to return to Operational mode.

Adjustment procedure :

Example : diagonal focusing of the green image.
Equalize diagonally the focus from left (bottom) to right (top) by turning screw 01 of the projected color.
Equalize now diagonally the focus from left (top) to right (bottom) by turning screw 00 located under the green lens.

Repeat the same procedure for the red and blue image using the corresponding screws.
To optimize the image focusing, repeat the optical lens focusing.

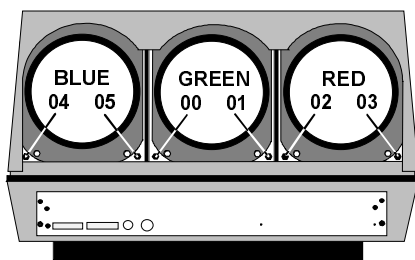

	Left 	Right
GREEN	00	01
RED	02	03
BLUE	04	05

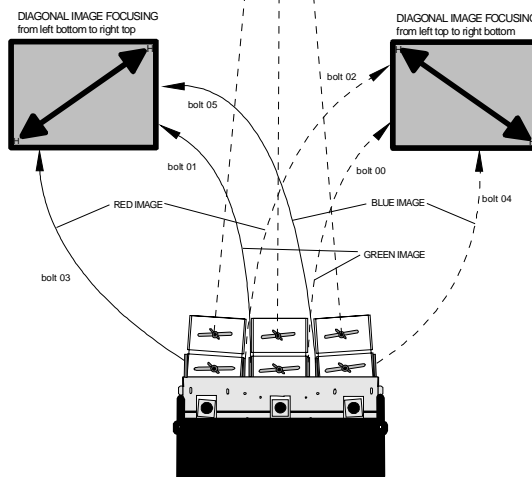
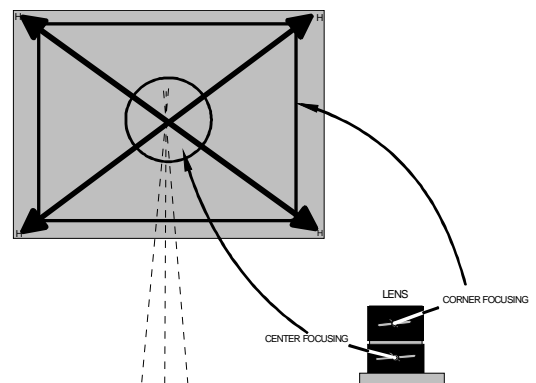
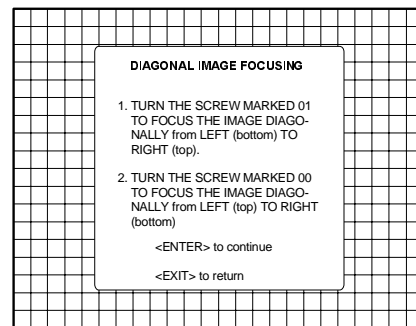

e.g. : Turning bolt 03 will influence the diagonal focus for Red from left bottom to tight top

After finishing the Installation Adjustment Procedures, the main menu returns on the screen. You are now able to start the alignment procedure for the projector. You have the choice between:

- Guided adjustment procedure;
- Random Access Adjustment procedure.

Press the <ENTER> key to continue with the chosen path.
Press the <EXIT> key to return to Operational mode.
Press the <ADJUST> key to return to Operational mode.

For detailed information about these adjustments, please refer to the Owner's Manual.

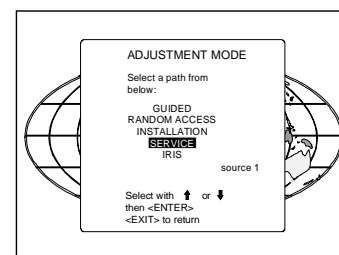

9

MESSAGES, WARNINGS AND FAILURE CODES

<p>SOURCE 01 Fh= 15.6 kHz Fv= 050 Hz</p>	<p>When selecting a new source, information about this source will be displayed on the screen. Source number, horizontal and vertical frequencies of the displayed source.</p>	<p>WARNING : source not available</p>	<p>The input is a valid input but the source is not connected to the input terminals or the input source is switched off.</p>
<p>SOURCE 01 Fh= 15.6 kHz Fv= 050 Hz</p>	<p>Announcement of the selected source.</p>	<p>WARNING : invalid key entry</p>	<p>When a wrong key is pressed on the RCU.</p>
<p>enter password xxxx</p>	<p>Message to enter your password. Password contains 4 digits.</p>	<p>WARNING : invalid code entry</p>	<p>Message when the entered password is wrong.</p>
<p>text on</p>	<p>These messages will be displayed on the screen when pushing the <TEXT> key.</p> <p>Text ON : the '<i>Bar scale indication</i>' will be enabled during the change of an analog control in the '<i>Operational mode</i>'. All warning and failure messages will be displayed.</p> <p>Text OFF : the '<i>Bar scale indication</i>' will be disabled during the change of an analog control in the '<i>Operational mode</i>'. All warning and failure messages will not be displayed.</p>	<p>WARNING : end of adjustment range</p>	<p>End of adjustment range.</p>
<p>text off</p>		<p>WARNING : input no longer available</p>	<p>Message will be displayed when the input source is no longer available. The following message then appears: '<i>check input signal or select new source</i>'.</p>
<p>PROJECTOR ADDRESS : 003</p>	<p>Indication of the projector address when activating the '<i>ADDRESS</i>' button on the RCU with a pencil or other small object.</p>	<p>check input signal or select new source</p>	<p>This message will be displayed after the message '<i>input no longer available</i>'. It asks to check the connections between the source and the projector or to check if the source is switched on.</p>
<p>WARNING : input not available</p>	<p>When using the projector with the RCVDS, this warning will be displayed when selecting an input slot of an RCVDS where the input board is missing.</p>	<p>WARNING : input selector not available</p>	<p>It warns you to check the power connection or the power status of the RCVDS. Next message will appear immediately on the screen : '<i>go to standby</i>'.</p>

WARNING : go to stand by	Projector will switch to 'Standby' when the RCVDS is no longer available.	FAILURE RCVDS communication error	Serial communication error between RCVDS and projector.
WARNING : invalid frequency input	The entered frequency or applied frequency of the source is out of the projector's range.	FAILURE RWI communication error	Hardware failure. Call a qualified service technician.
WARNING : default settings loaded in the E2PROM	Adjustment settings are lost. Reload using Projector Control Software via PC or MAC (if this option is available), or readjust image.	FAILURE IRIS communication error	Communication error between IRIS and the projector. Call a qualified service technician.
table is deleted	Message to inform that selected table is deleted. This message will be followed by 'confirm message', on which the user has to answer.	WAIT starting up IRIS	Message during the start up of the IRIS. Message will disappear when the IRIS is ready to accept commands.
FAILURE invalid RWI soft version	Wrong software version in your projector. Call for technical support.		
FAILURE I²C error addr. : 7FH3	Hardware failure. Call a qualified service technician for repair.		
FAILURE short circuit on I²C bus	Hardware failure. Call a qualified service technician for repair.		

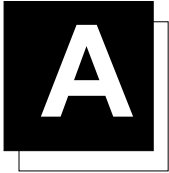

BARCO CEILING MOUNT SUPPORT

This appendix gives only an overview of the contents of the installation guidelines and some overview drawings.

The installation guidelines for the BARCO ceiling mounting support can be ordered from BARCO. The order number: R5975693.

Contents of the installation guidelines

1. Mounting instructions for the upper support to the ceiling
 - a. Position of the upper support on the ceiling
 - b. Mounting of the 4 screwed rods on the upper support
2. Projector placement on lower support
 - a. Projector placement on support
 - b. Location of controls for projector-position correction
3. Mounting instructions of the cord to lift up the projector
 - a. Mounting the cord support on the upper support
 - b. Cord insertion between the upper and lower support
 - c. Cord fixation
4. Lifting up and fixing the lower support (with projector) on the screwed rods
5. Alignment of the projector-support assembly
 - a. Projector water-level adjustment
 - b. Adjustment "projector axis perpendicular" to the screen surface
 - c. Projector movement forward or backward

Overview drawing of the total system

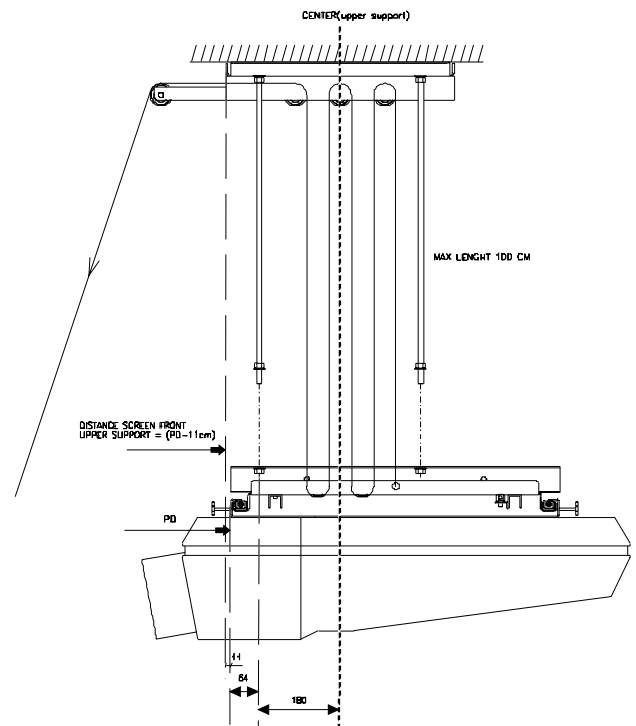

Exploded view of BARCO ceiling mount support

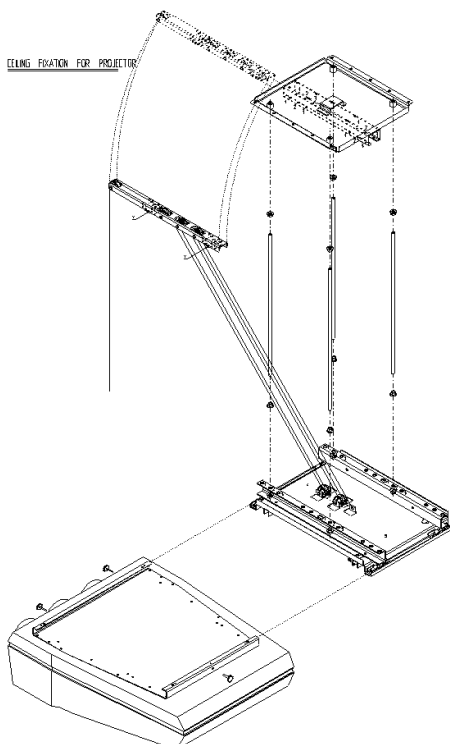

Projector position corrections

- Water-level adjustment

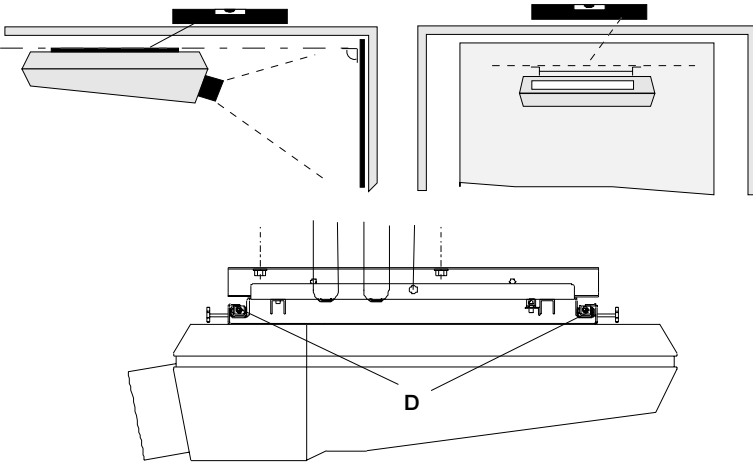

- Projector axis adjustment

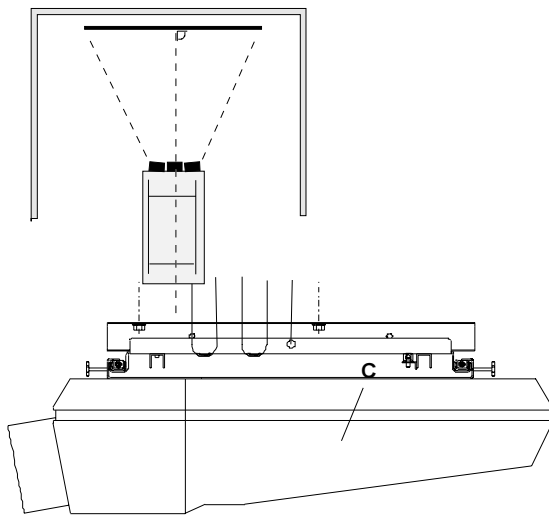

B

G2 ADJUSTMENT

Once the on-screen menu "G2 ADJUSTMENT" is displayed, proceed as follows :

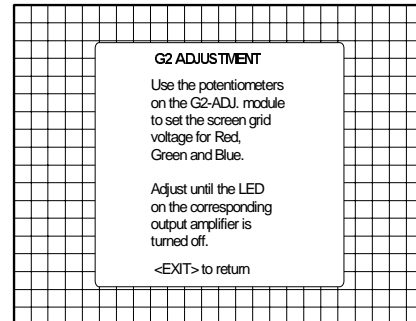

- Remove the top cover from the projector (see p.4-1) and open the front metal protection cover by turning out the 3 retaining screws on both sides.
- A green LED is mounted on each of CRT sockets (see Photo 2).
When selecting the G2 adjustment menu, these green LEDs must be out. If not, follow the procedure below to adjust the G2 :
 - Open the second metal cover by turning out the retaining screws on both sides and pivot the cover to the front side of the projector (see Photo 1);
 - Adjust the G2 potentiometers (see Photo 3) very slowly with a plastic tweaker until the LED of the corresponding amplifier just stops illuminating. Repeat the adjustment for the other colors;
 - After the three G2 potentiometers have been correctly adjusted, close both metal covers and secure with the retaining screws.

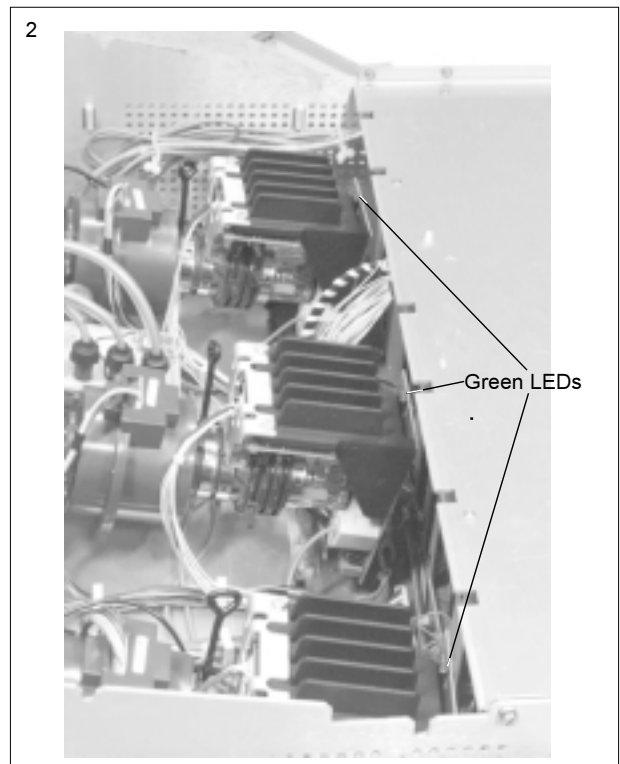
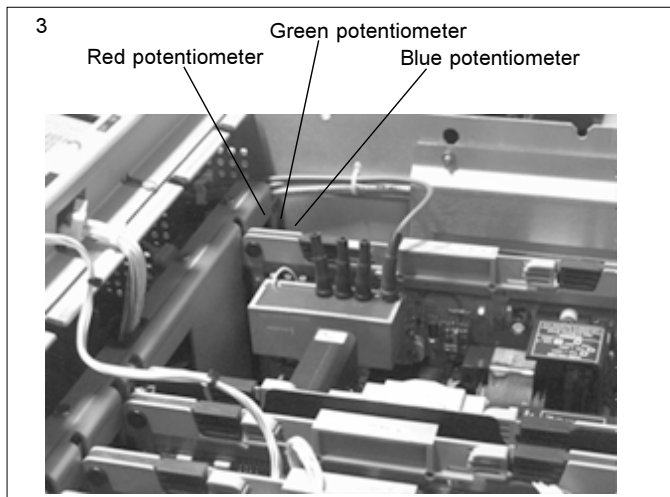
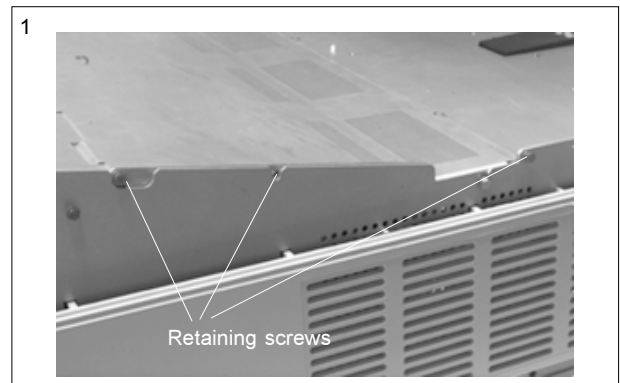

After finishing the adjustments :

Press the <ENTER> key to continue with the "SERVICE" menu.
Press the <EXIT> key to return to the "SERVICE" menu.
Press the <ADJUST> key to return to Operational mode.

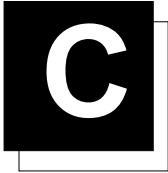

GAMMA CORRECTIONS

When entering the gamma corrections, a warning will be displayed :

*"RISK OF INCORRECT ADJUSTMENT OF THE PROJECTOR.
THE GAMMA CORRECTIONS ARE FACTORY ADJUSTED USING
AN ACTAS COLOR ANALYZER ! THEREFORE, ONLY QUALIFIED
INSTALLATION OR SERVICE PERSONNEL SHOULD PERFORM
THESE ADJUSTMENTS ! "*

If you are qualified, press the <ENTER> key to continue.

Gamma Corrections

Three items can be selected inside the "Gamma Corrections" menu: the Blue Gamma Correction, the R & B midlights and the factory preset.

To carry out the Blue Gamma Correction :

- Push the control stick forward or backward to highlight the item *BLUE GAMMA CORRECTION* in the menu and then press the <ENTER> key.

If the <EXIT> key is pressed, the projector will return to the *Service* menu.

- After the <ENTER> key is pressed, a text box with the message, "Adjust with arrow key", will be displayed on the screen.
- Push the control stick forward or backward to adjust the slope, a text box with a bar scale (Min to Max) will be displayed to visualize the magnitude of the correction.
- Push the control stick to the left or to the right to adjust the breakpoint, a text box with a numeric bar scale (0-99) will be displayed to visualize the magnitude of the correction.
- Press the <ENTER> key to return to the "Gamma Corrections" menu.

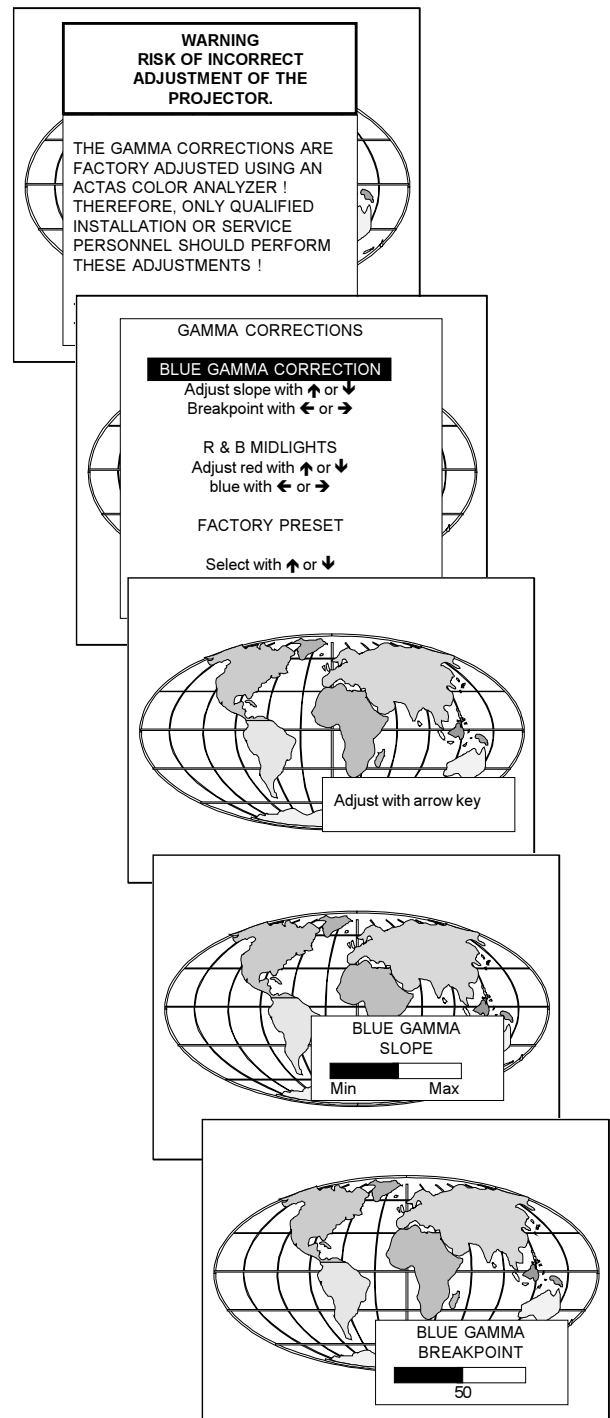

Gamma Corrections

To carry out the Red and Blue Midlights Correction :

- Push the control stick forward or backward to highlight the item *R & B MIDLIGHTS* in the menu and then press the <ENTER> key. If the <EXIT> key is pressed, the projector will return to the *Service* menu.
- After the <ENTER> key is pressed, a text box with the message "Adjust with arrow key", will be displayed on the screen.
- Push the control stick forward or backward to adjust the Red Midlights, a text box with a bar scale (0-16) will be displayed to visualize the magnitude of the correction.
- Push the control stick to the left or to the right to adjust the Blue Midlights, a text box with a bar scale (0-16) will be displayed to visualize the magnitude of the correction.
- Press the <ENTER> key to return to the "Gamma Corrections" menu.

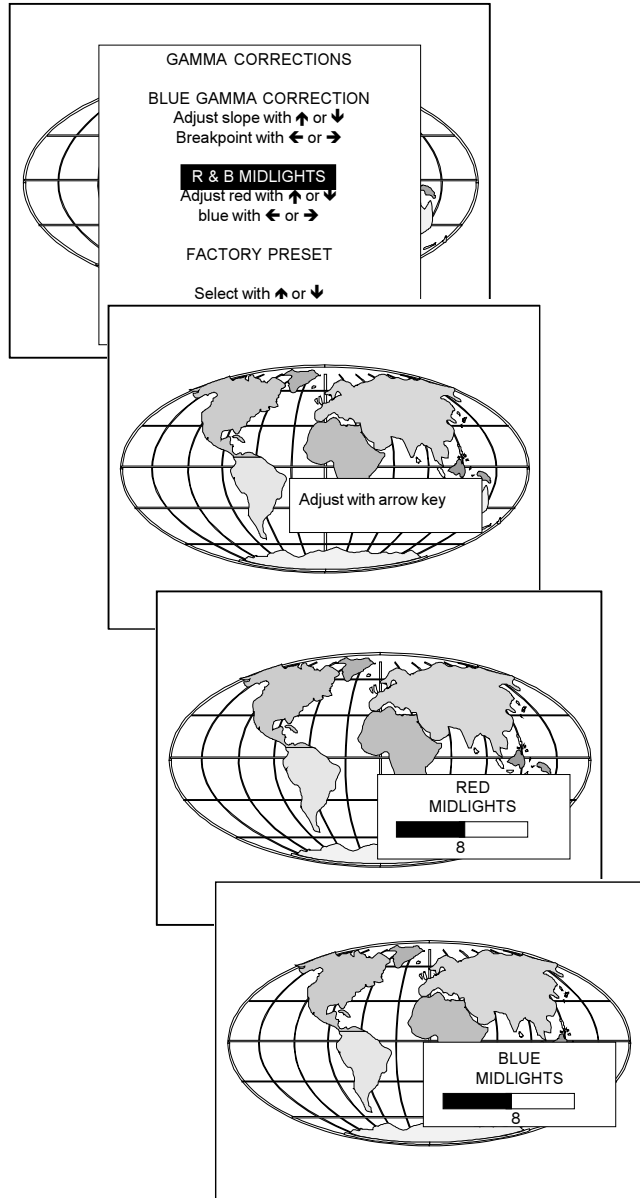

To set the parameters back to the factory preset values :

- Push the control stick forward or backward to highlight the item *FACTORY PRESET* in the menu and then press the <ENTER> key.
- Press the <EXIT> key to return to the *Service* menu.

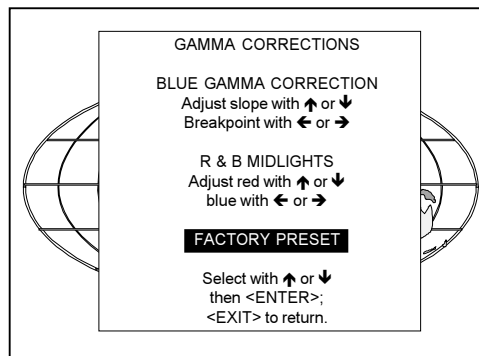

MATERIAL SAFETY DATA SHEET				Form Approved Bureau Budget No. 45-R0338			
SECTION I	MANUFACTURER'S NAME AND FSCM (<i>Federal Supply Code for Manufacturer's</i>) <i>BARCON.V.</i>			EMERGENCY PHONE NO. <i>32-56-368211</i>			
	ADDRESS (<i>Number, Street, City, State, and ZIP Code</i>) <i>Noordlaan 5 B-8520 KUURNE</i>						
	CHEMICAL NAME AND SYNONYMS <i>Ethylenglycol & Glycerol</i>			TRADE NAME AND SYNONYMS <i>Cooling liquid 512334</i>			
	CHEMICAL FAMILY <i>Polyalcohols</i>		FORMULA <i>C₂H₆O₂+C₃H₈O₃</i>				
	FEDERAL STOCK NUMBER (<i>FSN</i>)		GROSS WEIGHT (<i>LBS</i>)	OUTSIDE PACKAGE DIMENSIONS (<i>Inches</i>)			
	MIL-STD-1341/NATIONAL FIRE PROTECTION ASSOCIATION STD 704M SIGNAL						
FLAMMABILITY.....		HEALTH.....	REACTIVITY.....	SPECIFIC HAZARD.....			
SECTION II - HAZARDOUS INGREDIENTS	PAINTS, PRESERVATIVES, AND SOLVENTS	%	TRESHOLD LIMIT VALUE (<i>Units</i>)	ALLOYS AND METALLIC COATINGS	%	TRESHOLD LIMIT VALUE (<i>Units</i>)	
	PIGMENTS	/		BASE METAL	/		
	CATALYST	/		ALLOYS	/		
	VEHICLE	/		METALLIC COATINGS	/		
	SOLVENTS	/		FILLER METAL PLUS COATING OR CORE FLUX	/		
	ADDITIVES	/		OTHERS	/		
	OTHERS	/					
	HAZARDOUS MIXTURES OF OTHER LIQUIDS, SOLIDS, OR GASES					%	TRESHOLD LIMIT VALUE (<i>Units</i>)
SECTION III PHYSICAL DATA	BOILING POINTS (<i>°C.</i>)	<i>201°C</i>		SPECIFIC GRAVITY (<i>H₂O=1</i>)	<i>1.15</i>		
	VAPOR PRESSURE (<i>mm Hg.</i>)	<i>3 mm Hg</i>		PERCENT VOLATILE BY VOLUME (%)	/		
	VAPOR DENSITY (<i>AIR=1</i>)	<i>2.2</i>		EVAPORATION RATE (<i>.....=1</i>)	/		
	SOLUBILITY IN WATER	<i>∞</i>					
	APPEARANCE AND ODOR						
SECTION IV - FIRE AND EXPLOSION HAZARD DATA	FLASH POINT (<i>Method used</i>)			FLAMMABLE LIMITS	LOWER EXPLOSIVE LIMIT	UPPER EXPLOSIVE LIMIT	
	EXTINGUISHING MEDIA						
	SPECIAL FIRE FIGHTING PROCEDURES						
	UNUSUAL FIRE AND EXPLOSION HAZARDS						

SECTION V HEALTH HAZARD DATA	TRESHOLD LIMIT VALUE <i>100ppm</i>		
	EFFECTS OF OVEREXPOSURE		
	EMERGENCY AND FIRST AID PROCEDURES		
SECTION VI REACTIVITY DATA	STABILITY	UNSTABLE	CONDITIONS TO AVOID
		STABLE	X
	INCOMPATABILITY <i>(Materials to avoid)</i>		
	HAZARDOUS DECOMPOSITION PRODUCTS		
	HAZARDOUS POLYMERIZATION	MAY OCCUR	X
	WILL NOT OCCUR		
SECTION VII SPILL OR LEAK PROCEDURES	STEPS TO BE TAKEN IN CASE MATERIAL IS RELEASED OR SPILLED		
	<i>Rinse with water</i>		
	WASTE DISPOSAL METHOD		
SECTION VIII - SPECIAL PROTECTION INFORMATION	RESPIRATORY PROTECTION <i>(Specific type)</i>		
	VENTILATION	LOCAL EXHAUST	SPECIAL
		MECHANICAL <i>(General)</i>	OTHER
	PROTECTIVE GLOVES	EYE PROTECTION	
	OTHER PROTECTIVE EQUIPMENT		
SECTION IX SPECIAL PRECAUTIONS	PRECAUTIONS TO BE TAKEN IN HANDLING AND STORING		
	<i>Harmful if swallowed</i>		
	<i>Keep out of the reach of children</i>		
OTHER PRECAUTIONS			
<i>To avoid from oxidants</i>			

THE INFORMATION CONTAINED HEREIN IS BASED ON DATA CONSIDERED ACCURATE. HOWEVER, NO WARRANTY IS EXPRESSED OR IMPLIED REGARDING THE ACCURACY OF THESE DATA OR THE RESULTS TO BE OBTAINED FROM THE USE THEREOF. VENDOR ASSUMES NO RESPONSABILITY FOR INJURY TO VENDEE OR THIRD PERSONS PROXIMATELY CAUSED BY THE MATERIAL IF REASONABLE SAFETY PROCEDURES ARE NOT ADHERED TO AS STIPULATED IN THE DATA SHEET. ADDITIONALLY, VENDOR ASSUMES NO RESPONSABILITY FOR INJURY TO VENDEE OR THIRD PERSONS PROXIMATELY CAUSED BY ABNORMAL USE OF THE MATERIAL EVEN REASONABLE SAFETY PROCEDURES ARE FOLLOWED. FUTHERMORE, VENDEE ASSUMES THE RISK IN HIS USE OF THE MATERIAL.