

BARCO **VISION**
508

R9002130
R9002139

INSTALLATION MANUAL

BARCO

BARCO PROJECTION SYSTEMS

BARCO **VISION**
508

R9002130
R9002139

INSTALLATION MANUAL

Date :
180199

Rev :
01

Art. No. :
R5975029

Due to constant research, the information in this manual is subject to change without notice.

Produced by BARCO NV, January 1999.
All rights reserved.

Trademarks are the rights of their respective owners.

BARCO n.v./Projection Systems

Noordlaan 5

B-8520 Kuurne

Belgium

Tel : +32/56/368211

Fax : +32/56/351651

E-mail : sales.bps@barco.com

Visit Barco at the web : <http://www.barco.com>

Printed in Belgium

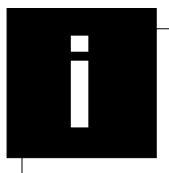

TABLE OF CONTENTS

WARNINGS	1-1
SAFETY INSTRUCTIONS	1-1
On safety	1-2
On installation	1-2
On servicing	1-2
On cleaning	1-2
On repacking	1-2
On illumination	1-2
UNPACKING & DIMENSIONS	2-1
Unpacking	2-1
Projector dimensions	2-2
INSTALLATION GUIDELINES	3-1
* Environment	3-1
* What about ambient light ?	3-1
* Which screen type?	3-1
* What image size? How big should the image be?	3-1
* Where to install the projector?	3-2
* How to install the projector?	3-2
INSTALLATION SET UP	4-1
Access to controls	4-1
Scan adaptation	4-2
PROJECTOR SET UP	5-1
Projector Set Up	5-1
Password mode	5-1
Setting the projector address	5-2
Power up mode	5-2
Baud rate for communication	5-2
POWER (MAINS) CONNECTION	6-1
Input power (mains) voltage adaptation	6-1
Power (mains) cord connection	6-1
Fuses	6-2
Switching on/off	6-2
INSTALLATION ADJUSTMENTS	7-1
Entering the adjustment mode	7-1
Overview flow chart installation mode	7-2
Installation mode start up	7-2
Scheimpflug adjustment	7-4
Optical lens focusing	7-5
Electrical focusing	7-5
Raster centering	7-6
CRT projection angle adjustment	7-6
Alignment of the projector	7-9
Appendix A : G2 adjustment	A-1

1

SAFETY INSTRUCTIONS

Notice on Safety

This equipment is built in accordance with the requirements of the international safety standards EN60950, UL 1950 and CSA C22.2 No.950, which are the safety standards of information technology equipment including electrical business equipment.

These safety standards impose important requirements on the use of safety critical components, materials and isolation, in order to protect the user or operator against risk of electric shock and energy hazard, and having access to live parts.

Safety standards also impose limits to the internal and external temperature rises, radiation levels, mechanical stability and strength, enclosure construction and protection against the risk of fire.

Simulated single fault condition testing ensures the safety of the equipment to the user even when the equipment's normal operation fails.

INSTALLATION INSTRUCTIONS

Before operating this equipment please read this manual thoroughly, and retain it for future reference.

Installation and preliminary adjustments should be performed by qualified BARCO personnel or by authorized BARCO service dealers.

OWNER'S RECORD

The part number and serial number are located at the back side of the projector. Record these numbers in the spaces provided below. Refer to them whenever you call upon your BARCO dealer regarding this product.

PART NUMBER:

SER. NUMBER:

DEALER:

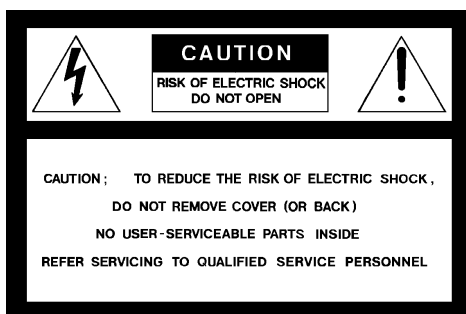

The lightning flash with an arrowhead within a triangle is intended to tell the user that parts inside this product may cause a risk of electrical shock to persons.



The exclamation point within a triangle is intended to tell the user that important operating and/or servicing instructions are included in the technical documentation for this equipment.

WARNING
TO PREVENT FIRE OR ELECTRICAL SHOCK HAZARD, DO NOT EXPOSE THIS EQUIPMENT TO RAIN OR MOISTURE

FEDERAL COMMUNICATION COMMISSION (FCC STATEMENT)

This equipment has been tested and found to comply with the limits of a class B digital device, pursuant to Part 15 of the FCC Rules. These limits are designed to provide reasonable protection against harmful interference when the equipment is operated in a residential environment. This equipment generates, uses and can radiate radio frequency energy and, if not installed and used in accordance with the instruction manual, may cause harmful interference to radio communications. However, there is no guarantee that interference will not occur in a particular installation. If this equipment does cause harmful interference to radio or television reception, which can be determined by turning the equipment off and on, the user is encouraged to try to correct the interference by one or more of the following measures :

- Reorient or relocate the receiving antenna.
- Increase the separation between the equipment and receiver.
- Connect the equipment into an outlet on a circuit different from that to which the receiver is connected.
- Consult the dealer or an experienced radio/TV technician for help.

Note :

The use of shielded cables is required to comply within the limits of Part 15 of FCC rules and EN55022.

- * All the safety and operating instructions should be read before using this unit.
- * The safety and operating instructions manual should be retained for future reference.
- * All warnings on the equipment and in the documentation manuals should be adhered to.
- * All instructions for operating and use of this equipment must be followed precisely.

On safety

1. This product should be operated from an AC power source. This projector may be connected to an IT-power system.

Operating AC power voltage of the projector:

BARCOVISION 508
Art. No. R9002130 (230V AC)
Art. No. R9002139 (120V AC)

Consult your dealer to switch over from 230Vac to 120 Vac or from 120Vac to 230 Vac.

If you are not sure of the type of AC power available, consult your dealer or local power company.

2. This product is equipped with a 3-wire grounding plug, a plug having a third (grounding) pin. This plug will only fit into a grounding-type power outlet. This is a safety feature. If you are unable to insert the plug into the outlet, contact your electrician to replace your obsolete outlet. Do not defeat the purpose of the grounding-type plug.

WARNING FOR THE CUSTOMERS: THIS APPARATUS MUST BE

Safety Instructions

GROUND (EARTHED) via the supplied 3 conductor AC power cable.
(If the supplied power cable is not the correct one, consult your dealer.)

A. Mains lead (Power cord) with CEE 7 plug:

The wires of the mains lead are colored in accordance with the following code.

Green and yellow: earth (safety earth)
Blue: neutral
Brown: line (live)

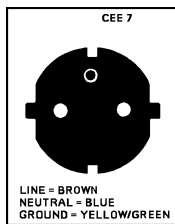

B. Power cord with ANSI 73.11 plug:

The wires of the power cord are colored in accordance with the following code.

Green/yellow: ground
White: neutral
Black: line (live)

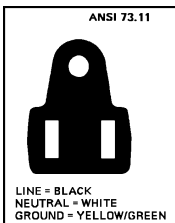

3. Do not allow anything to rest on the power cord. Do not locate this product where persons will walk on the cord.

To disconnect the cord, pull it out by the plug. Never pull the cord itself.

4. If an extension cord is used with this product, make sure that the total of the ampere ratings on the products plugged into the extension cord does not exceed the extension cord ampere rating. Also make sure that the total of all products plugged into the wall outlet does not exceed 15 amperes.

5. Never push objects of any kind into this product through cabinet slots as they may touch dangerous voltage points or short out parts that could result in a risk of fire or electrical shock.

Never spill liquid of any kind on the product. Should any liquid or solid object fall into the cabinet, unplug the set and have it checked by qualified service personnel before resuming operations.

6. Lightning - For added protection for this video product during a lightning storm, or when it is left unattended and unused for long periods of time, unplug it from the wall outlet. This will prevent damage to the projector due to lightning and AC power-line surges.

On installation

1. Do not place this equipment on an unstable cart, stand, or table. The product may fall, causing serious damage to it.

2. Do not use this equipment near water.

3. Slots and openings in the cabinet and the back or bottom are provided for ventilation; to ensure reliable operation of the product and to protect it from overheating, these openings must not be blocked or covered. The openings should never be blocked by placing the product on a bed, sofa, rug, or other similar surface. This product should never be placed near or over a radiator or heat register.

The projector should not be placed in a built-in installation or enclosure unless proper ventilation is provided.

4. Do not block the projector cooling fans or free air movement under and around the projector. Loose papers or other objects may not be nearer to the projector than 4" on any side.

On servicing

Do not attempt to service this product yourself, as opening or removing covers may expose you to dangerous voltage potentials and risk of electric shock!

Refer all servicing to qualified service personnel.

Unplug this product from the wall outlet and refer servicing to qualified service personnel under the following conditions:

- When the power cord or plug is damaged or frayed.
 - If liquid has been spilled into the equipment.
 - If the product has been exposed to rain or water.
 - If the product does not operate normally when the operating instructions are followed.
- Note : Adjust only those controls that are covered by the operating instructions since improper adjustment of the other controls may result in damage and will often require extensive work by a qualified technician to restore the product to normal operation.
- If the product has been dropped or the cabinet has been damaged.
 - If the product exhibits a distinct change in performance, indicating a need for service.

Replacement parts - When replacement parts are required, be sure the service technician has used original BARCO replacement parts or authorized replacement parts which have the same characteristics as the BARCO original part. Unauthorized substitutions may result in degraded performance and reliability, fire, electric shock or other hazards. Unauthorized substitutions may void warranty.

Safety check - Upon completion of any service or repairs to this projector, ask the service technician to perform safety checks to determine that the product is in proper operating condition.

On cleaning

Unplug this product from the wall outlet before cleaning. Do not use liquid cleaners or aerosol cleaners. Use a damp cloth for cleaning.

- To keep the cabinet looking brand-new, periodically clean it with a soft cloth. Stubborn stains may be removed with a cloth lightly dampened with mild detergent solution. Never use strong solvents, such as thinner or benzine, or abrasive cleaners, since these will damage the cabinet.
- To ensure the highest optical performance and resolution, the projection lenses are specially treated with an anti-reflective coating, therefore, avoid touching the lens. To remove dust on the lens, use a soft dry cloth. Do not use a damp cloth, detergent solution, or thinner.

On repacking

Save the original shipping carton and packing material; they will come in handy if you ever have to ship your equipment. For maximum protection, repack your set as it was originally packed at the factory.

On illumination

In order to obtain the best quality for the projected image, it is essential that the ambient light which is allowed to fall on the screen be kept to an absolute minimum.

When installing the projector and screen, care must be taken to avoid exposure to ambient light directly on the screen. Avoid adverse illumination on the screen from direct sunlight or fluorescent lighting fixtures.

The use of controlled ambient lighting, such as incandescent spot light or a dimmer, is recommended for proper room illumination. Where possible, care should also be taken to ensure that the floors and walls of the room in which the projector is to be installed are non-reflecting, dark surfaces. Brighter surfaces will tend to reflect and diffuse the ambient light and hence reduce the contrast of the projected image on the screen.

2

UNPACKING AND DIMENSIONS

Unpacking

To open the banding, pull on the clip as shown in the first drawing.

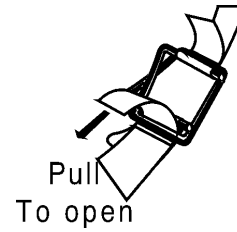

Take the projector out of its shipping carton and place it on a table. Save the original shipping carton and packing material, they will come in handy if you ever have to ship your projector. For maximum protection, repack your projector as it was originally packed at the factory.

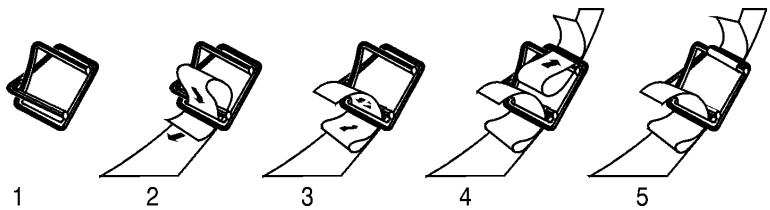

Contents of the shipped box :

- 1 BARCOVISION 508.
- 1 remote control + 9V battery
- 1 power cable with outlet plug type CEE7 or ANSI 73.11.
- 1 owner's manual.
- 1 installation manual.

Projector dimensions

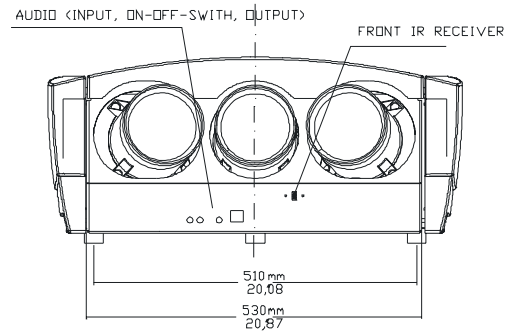
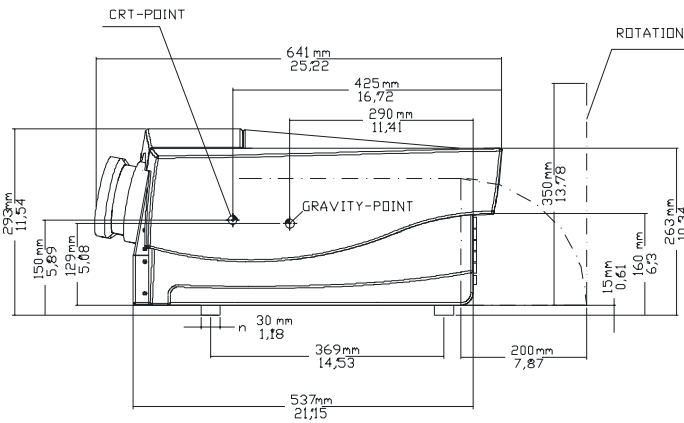

LENSTYPE : DELTA 216

APPROX. WEIGHT : 36 KG

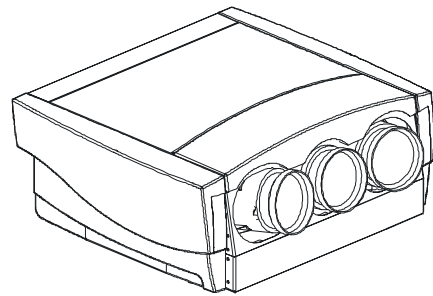
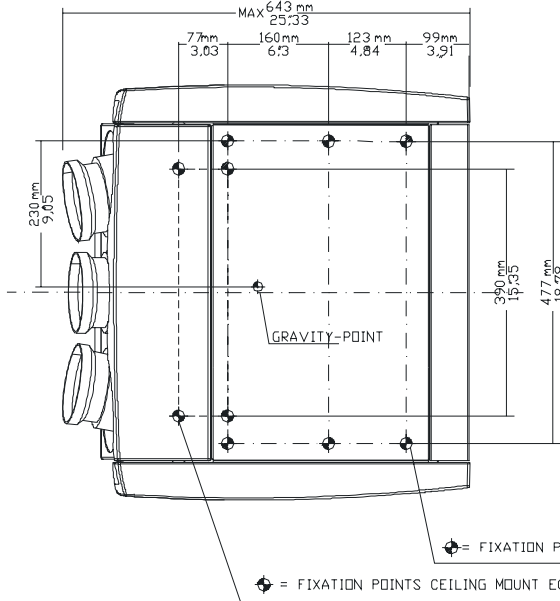

3

INSTALLATION GUIDELINES

Installation guidelines

Careful consideration of things such as image size, ambient light level, projector placement and type of screen to use are critical to the optimum use of the projection system.

* Environment

Do not install the projection system in a site near heat sources such as radiators or air ducts, or in a place subject to direct sunlight, excessive dust or humidity. Be aware that room heat rises to the ceiling; check that the temperature near the installation site is not excessive.

* What about ambient light ?

The ambient light level of any room is made up of direct or indirect sunlight and the light fixtures in the room. The amount of ambient light will determine how bright the image will appear. So, avoid direct light on the screen.

Windows that face the screen should be covered by opaque drapery while the set is being viewed. It is desirable to install the projecting system in a room whose walls and floor are of non-reflecting material. The use of recessed ceiling lights and a method of dimming those lights to an acceptable level is also important. Too much ambient light results in a 'wash out' of the projected image. This appears as less contrast between the darkest and lightest parts of the image. With bigger screens, the 'wash out' becomes more important. As a general rule, darken the room to the point where there is just sufficient light to read or write comfortably. Spot lighting is desirable for illuminating small areas so that interference with the screen is minimal.

* Which screen type?

There are two major categories of screens used for projection equipment. Those used for front projected images and those for rear projection applications.

Screens are rated by how much light they reflect (or transmit in the case of rear projection systems) given a determined amount of light projected toward them. The 'GAIN' of a screen is the term used. Front and rear screens are both rated in terms of gain. The gain of screens range from a white matte screen with a gain of 1 (x1) to a brushed aluminized screen with a gain of 10 (x10) or more. The choice between higher and lower gain screens is largely a matter of personal preference and another consideration called the Viewing angle.

In considering the type of screen to choose, determine where the viewers will be located and go for the highest gain screen possible. A high gain screen will provide a brighter picture but reduce the viewing angle.

For more information about screens, contact your local screen supplier.

* What image size? How big should the image be?

The BARCOVISION 508 is designed for projecting an image width from 1.4m (4.6') to 7m (23') with an aspect ratio of 4 to 3. It leaves the BARCO factory, adjusted as a ceiling front projector for a screen width of 2.4m. Changing the image size from the factory preset requires a realignment of the projector.

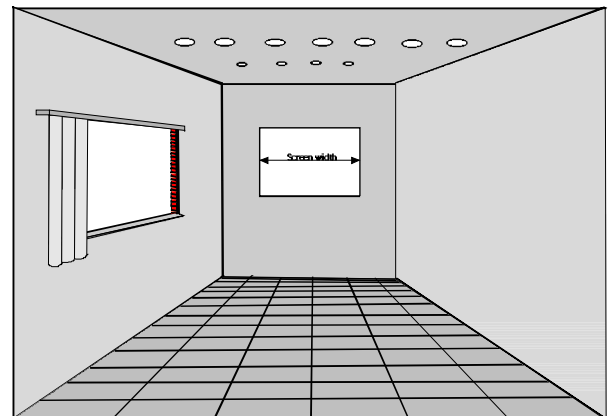
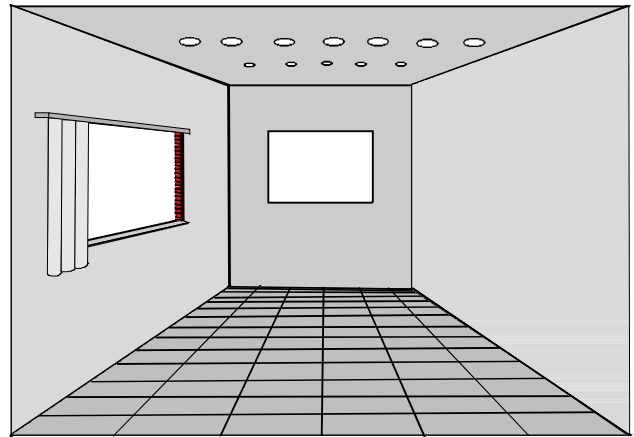

*** Where to install the projector?**

To indicate a correct installation position it is necessary to know the distance :

- projector - ceiling
- projector - screen

To find this correct position for the projector, equipped with HD145 lenses, formulas are given in the next paragraph.

Abbreviations used on drawing and diagrams on next pages

B = Distance between ceiling and top of the screen.

A = Correction Value, extra value to be added to B to obtain the correct installation position. (In some cases the A value can be negative.)

CD = Total distance between projector and ceiling.

CD = A + B (When the result is negative, enlarge the distance between ceiling and top of the screen, mount screen lower, until CD becomes zero or positive)

SW = Screen width.

PD = Perpendicular distance between screen and projector.

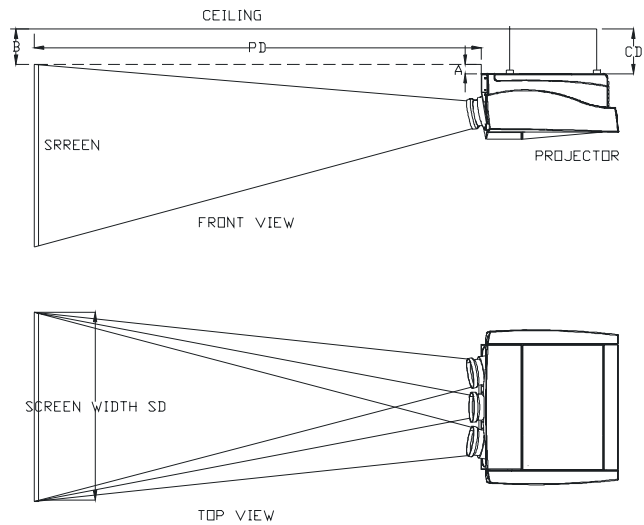

Formulas for Projector to screen distance and correction value A with regard to the screen width for *DELTA 216 lenses* (metric).

Formulas (metric)

$$PD[m] = 1.1431 \times SW[m] + 0.093$$

$$A[cm] = 14.14 \times SW[m] - 18.21$$

Max phosphor width on CRT = 11 cm

Formulas for Projector to screen distance and correction value A with regard to the screen width for *DELTA 216 lenses* (inch).

Formulas (inch)

$$PD = 1.1431 \times SW + 3.661$$

$$A = 0.1414 \times SW - 7.169$$

Max phosphor width on CRT = 4.33 inch

*** How to install the projector?**

Ceiling mount or table mount?

To install the projector, apply always the BARCO kits which are specially designed for this function.

BARCO ceiling support.

Always use the BARCO ceiling support to attach your projector to the ceiling. (BARCO order number : R9827990)

The installation instruction for this support is enclosed in the packet of the set.

BARCO projection table.

Height adaptable projection table provides a stable stand for your projector, and makes it possible to adapt the projector perfectly to the local requirements. (BARCO order number R9827740).

4

INSTALLATION SET UP

Access to controls

Opening procedure :

During the projector set up and installation it is necessary to remove the side and top covers.

First remove the top cover, covering the lenses :

- Turn both lock screws counter clockwise until they are raised by the springs.
- Lift up the cover and remove.

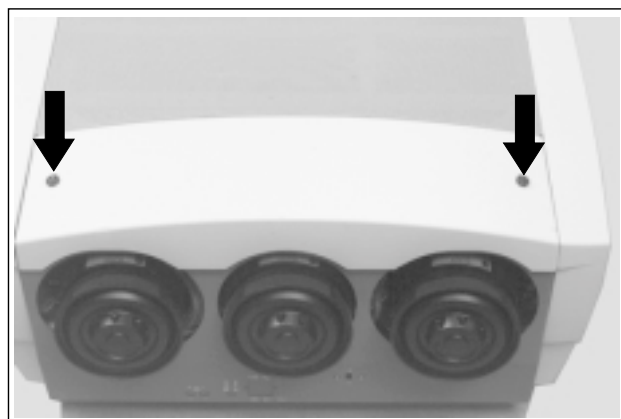

To remove the second top cover, covering the electronics, first the side covers have to be removed.

Removing the side covers :

- Turn out the three black screws on the bottom of the side covers.
- Tilt the side cover and lift it up.
- Repeat the same for the other side cover.



Removing the second top cover :

- Loosen the four M4 screws.
- Slide the cover a few to the back and lift up.

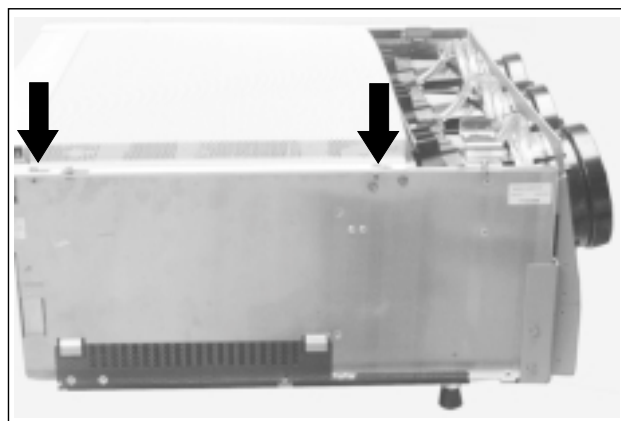

Scan adaptation

The scanning can be switched by turning the Horizontal and Vertical scan connectors.

To change the scanning, it is necessary to open the projector top cover (see "Access to control").

To gain access to the connectors, the top frame has to be turned 90° to the back until it grips into its locks. Therefore, the following the next procedure :

- Remove the four screws, two on each side, that are fixing the heatsinks to the frame (image 1).

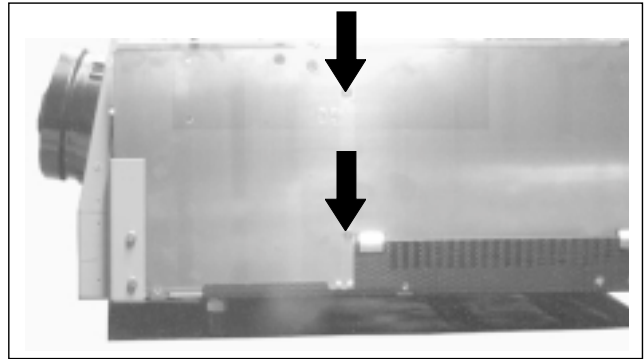

- Remove three screws that are fixing the frame to the metal chassis.

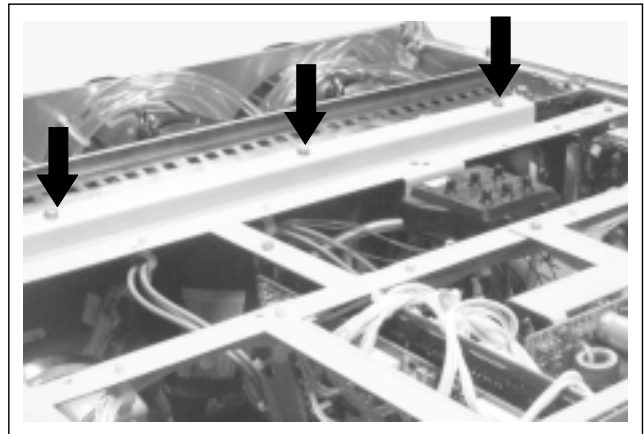

- Pivot the frame 90° to the back. It is possible that you have to pull strongly on the frame to open it.

WARNING

TURN OFF PROJECTOR AND UNPLUG THE POWER CORD BEFORE CHANGING THE SCAN DIRECTION.



Front / Table	Front / Ceiling	Rear / Table	Rear / Ceiling
Horizontal scan inversion			
Vertical scan inversion			

A : Horizontal scan inversion

Three connectors are used, one for each horizontal deflection coil. When changing the horizontal scan, insure that all three connectors are set in the same position. See position of the connectors for the corresponding projector configuration.

B : Vertical scan inversion

Three connectors are used, one for each vertical deflection coil. When changing the vertical scan, insure that all three connectors are set in the same position. See position of the connectors for the corresponding projector configuration.

After scan inversion, close the chassis, re-install the second top cover, the side covers and the lens top cover. To install the side covers :

- Hook the side cover on the both notches and
 - secure on with the three black screws on the bottom side.
- Reconnect the power cord to the wall outlet.

Note

Switching over from floor to ceiling or vice versa requires a complete readjustment of picture geometry and convergence.

Check of the correct connector position

Note : this check procedure can only be done after power (mains) connection. So, first continue with the *projector set up* and the *connections* and then return to this checking procedure.

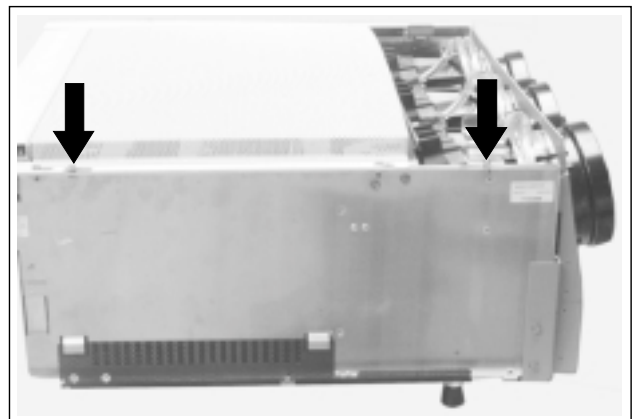

Installation Set Up

Switch on the BARCOVISION 508 and press **ADJUST** to start up the adjustment mode. Select with the control disk 'Service' and press **ENTER**. The service menu will be displayed. Select 'PROJECTOR SET UP' and press **ENTER**. Select 'IDENTIFICATION' and press **ENTER**. On this screen, information is given about the projectors configuration.

Configuration when leaving the factory : ceiling/front configuration.

Follow next procedure to check the configuration :

- switch on the projector.
- the projector starts up on the last selected source.
- press the **ADJUST** key.
- highlight 'service' with the control disc and press **ENTER**.
The 'service mode menu' will be displayed
- select with the control disc 'Projector set up' and press **ENTER**.
The 'Projector set up menu' will be displayed.
- Select with the control disc 'Identification' and press **ENTER**.

The projector displays the Identification screen

This screen gives information about the projector configuration in the subject 'config'.

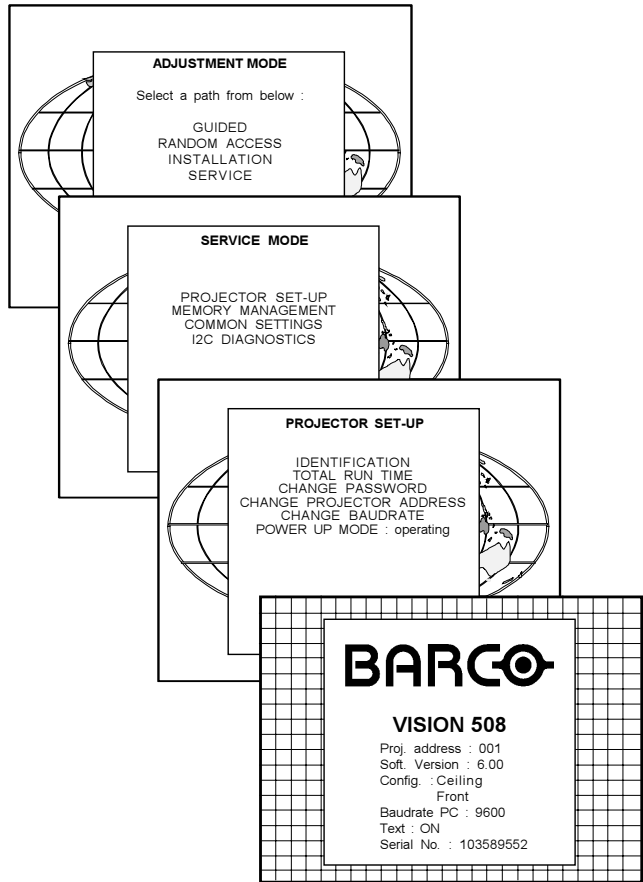

5

PROJECTOR SET UP

Projector Set Up

The software takes care of the set up of the projector.

- projector address
- power up
- baud rate (9600)
- password (strap is provided to disable)

Password mode

With strap J5 on the controller unit, the important projector adjustments can be protected with a password. When the password feature is enabled (strap mounted), the customer has to enter a password before he can enter the specific adjustment.

When the password menus are disabled (strap is open), all adjustments are free. This position of the strap is useful for qualified service technicians because they do not need a password during service.

Position of the strap (to gain access to the strap, see 'Access to Controls'):

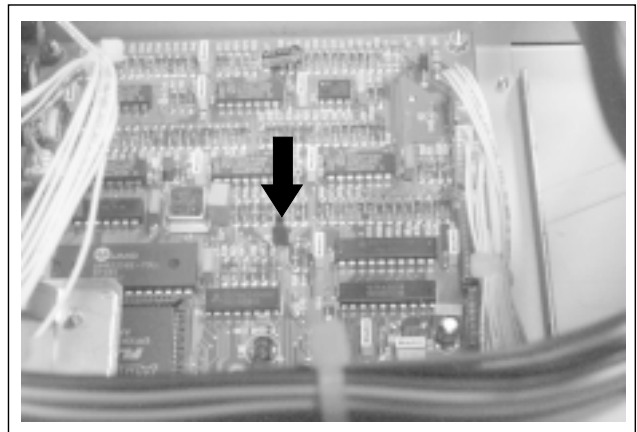

Setting the projector address

The projector's address may be set to any value between 0 and 255. When the address is set, the projector can be controlled now by a:

- RCU for addresses between 0 and 9.
- computer, e.g. IBM PC (or compatible), Apple MAC, etc., for addresses between 0 and 255 (only if the optional RS232 communication port is installed).

Note: a projector will respond to a RCU set to an address of 0 regardless of what address is set in the projector itself.

Address setting is a software setup of your projector which must be done during installation.

Note: With the address button on the RCU, the projector will display its own address on the screen. Once the address button is pressed, to continue using your RCU, it is necessary to enter an address with the numeric keys, even when the address remains the same.

Power up mode.

The projector can start up in two different modes. The start up mode is determined by the software.

1. Operational mode:

When the power switch on the back of the projector is pressed, the projector displays the last selected source if available, otherwise it remains on that source number until the source becomes available.

2. Stand by mode:

When the power switch on the back of the projector is pressed, the projector goes into stand-by. The stand-by key on the RCU or the local keypad is used to turn the projector ON and OFF.

Baud rate for communication with a computer

Computer communication is only available when the optional RS232 communication port is installed.

The communication speed between projector and computer, e.g. PC or MAC, is fixed at 9600 baud rate.

6

POWER CONNECTION

Power (mains) cord connection

Use the supplied power cord to connect your projector to the wall outlet. Plug the female power connector into the male connector at the front of the projector.



120 / 230 V
4 / 2.5 A
60 / 50 Hz
300 W

Input power (mains) voltage adaptation.

Attention

The BARCOVISION 508 - R9002130 leaves the factory to operate on a mains (power) input of 230 Vac.

Adaptation of the power input of the projector from 230 VAC to 120 VAC or vice versa is possible. Follow the procedure as described below.

Procedure

- Unplug the power cord from the power input on the rear panel.
- Remove the left side cover, right side cover, top cover and top mesh and take off the rear metal plate (see 'Access to Controls').

Power Connection

- Pull out the 'power selector plug' and re-insert it with the correct power indication upside, depending on the wall outlet in the room.
- Re-mount the rear metal plate, top cover, top mesh, left and right side cover.

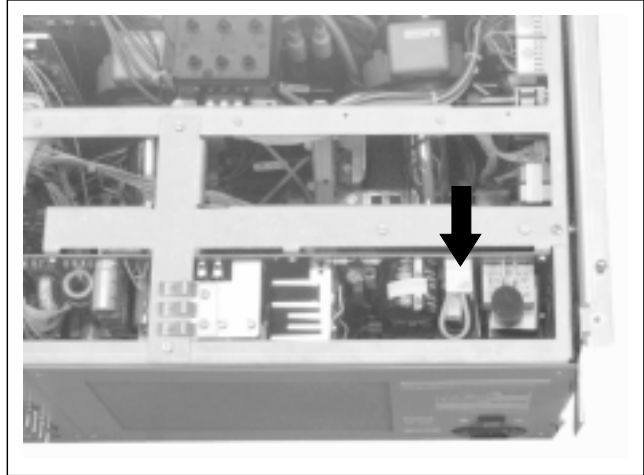

Fuses

Warning

For continued protection against fire hazard :

- replace with the same type of fuse
- refer replacement to qualified service personnel

Fuse type : 2 x T5A/250V (Barco order number : R314104)

Switching on/off

The projector is switched ON and OFF using the power (mains) switch ON/OFF.

Pressed : ON

Not pressed : OFF

The projector can start now in the 'operational mode' (image displayed) or in the 'stand by mode' (see projector set up)

Stand by indication lamp :

green : projector in operational mode

red : projector is in stand by.

- STD BY / NORMAL
- PAUSE
- COINCIDENCE
- EHT HOLD DOWN
- IRCODERXD

7

INSTALLATION ADJUSTMENTS

Entering the adjustment mode

Press **ADJUST** to enter the adjustment mode.

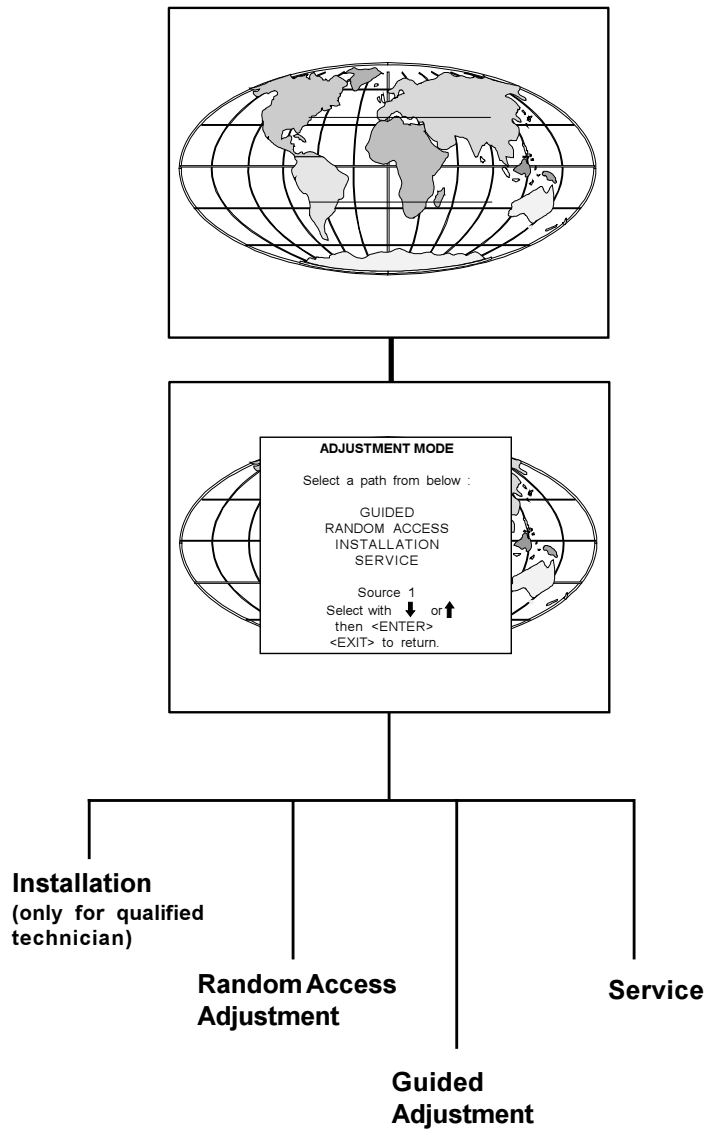

Overview flow chart installation mode.

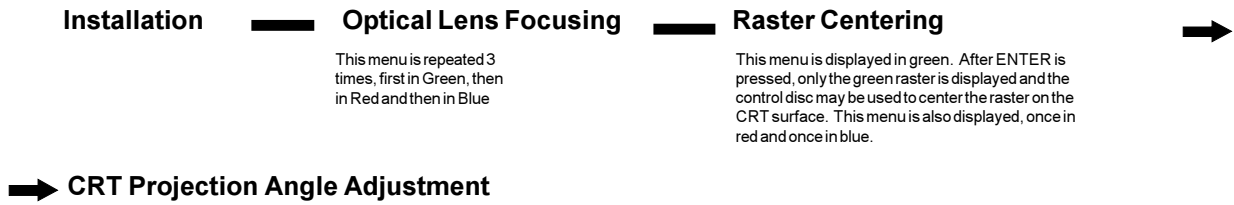

Installation mode start up

It will be necessary to perform several mechanical adjustments while in the installation mode. Remove the top cover in order to gain access to the adjustment points (see Access to controls).
Two possible ways to enter the installation mode :

a) Using the RCU.

Press the **ADJUST** key.
The projector displays the path selection menu.

b) Using the local keypad.

Press the **ADJUST** key.
The projector displays the *General access menu*.

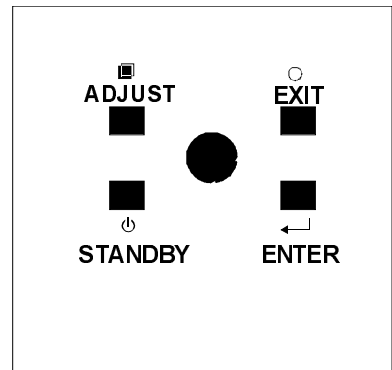

Use the control disc to highlight *enter ADJUST* and press **ENTER**. The path selection menu will be displayed.

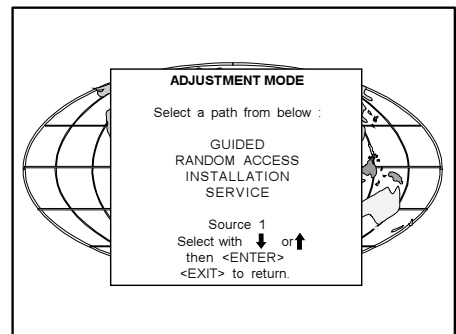
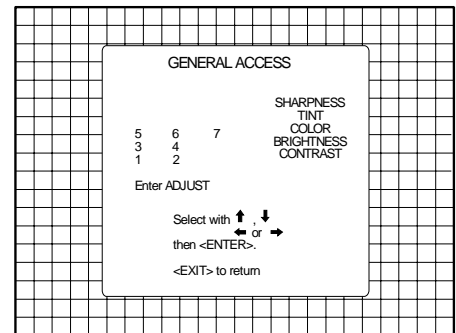

Push the control disc up or down to highlight "Installation" and press **ENTER**.

ENTER continues displaying a **WARNING**.
EXIT returns to operational mode.
ADJUST returns to operational mode.

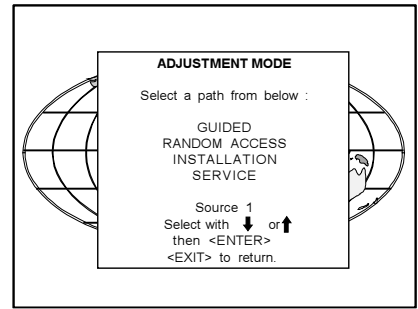

A warning will be displayed on the screen.
 If you are qualified installation or service personnel, press **ENTER** to start up the installation mode.

When entering the installation mode, the projector will automatically switch to the internal pattern on 15 kHz/50 Hz.

ENTER asks for your password.
EXIT returns to the path selection menu.

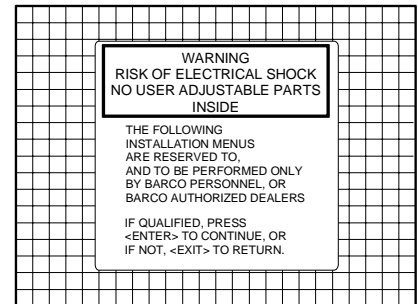

When the password mode is active, your password will be asked.

Your password contains 4 digits.

- a) Adjusting the projector with the RCU.
 Enter the digits with the numeric keys on the RCU.

Example : 2 3 1 9

For each digit entered, a 'X' appears on the screen under the displayed text 'enter password'.

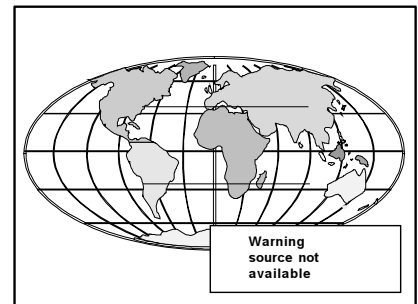

When your password is correct, you get access to the 'Adjustment mode'.

When the entered password is wrong, The message '*Wrong password !!!*' will be displayed. The projector stays on the previous selected item.

Factory programmed password :

0000

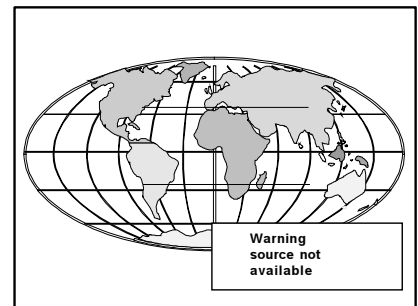

- b) adjusting the projector with the local keypad.

When the 'compose password' menu is displayed, select with the control disc the first digit of your password and press **ENTER**. Continue by selecting the second digit with the control disc and press **ENTER**. Handle in the same way for the third and fourth digit.

When your password is correct, you get access to the 'Adjustment mode'.

When the entered password is wrong, the message '*Wrong password*' will be displayed.

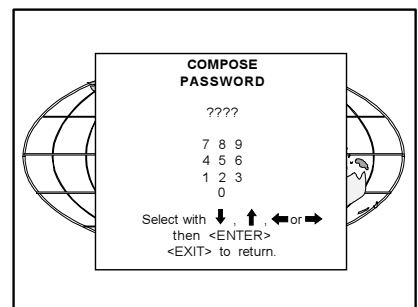

Optical lens focusing

The optical focusing procedure is performed separately for each lens. The appropriate CRT will be switched on as the user proceeds through the optical focusing adjustment sequence.

Each lens has one focus adjustment point. The projected image is focused by loosening the wing nut of the lens and rotating the lens barrel until the image is clearly focused.

Press **ENTER** key to continue.

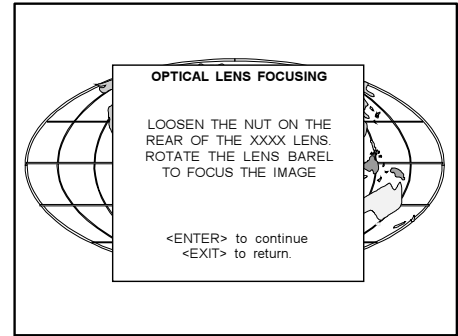

XXXX = respectively red, green and blue.

ENTER continues to Raster centering.
EXIT returns to scheimpflug adjustment
ADJUST returns to operational mode.

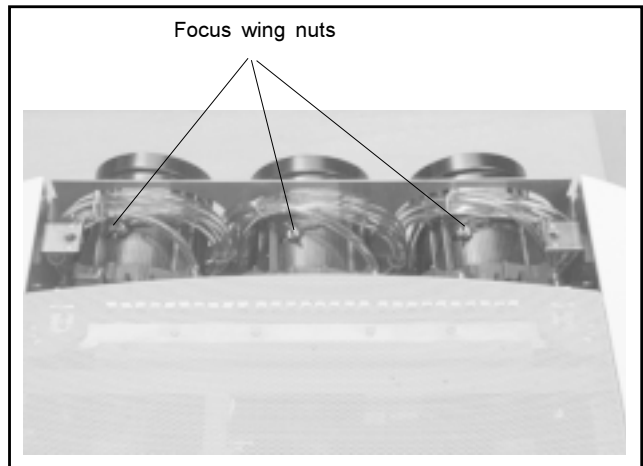

Electrical focusing

The electrical focus for red, green and blue is factory preset. When they have to be readjusted, follow the procedure as described below:

- Ensure the lenses are correctly focused.
- Open the top cover (see 'Access to Controls')
- Adjust separately the focus control for red, green and blue for the sharpest image on the screen.

Raster centering

The raster must be centered on the CRT screen surface of each tube, therefore, it is necessary to look into the lenses.

Warning : In order to ensure maximum CRT longevity and to avoid CRT damage, do not shift the raster outside the phosphor area of the CRT.

Press **ENTER** to display the raster on the green CRT.

Look into the green lens and shift the raster with the control disc until it is centered in the middle of the CRT faceplate.

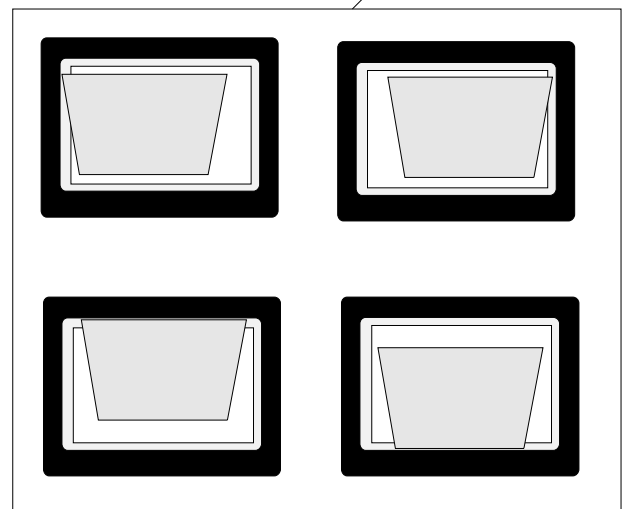
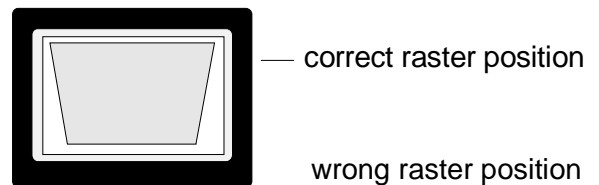
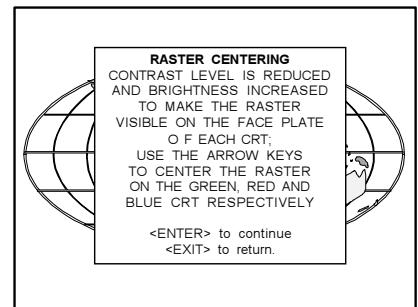
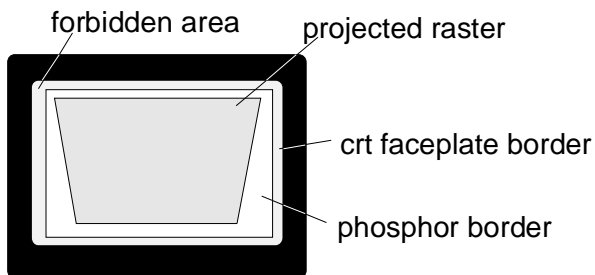

Press **ENTER** to activate the raster on the Red CRT faceplate. Shift the raster with the control disc until the raster is centered in the middle of the CRT faceplate.

Press **ENTER** to activate the raster on the Blue CRT faceplate. Shift the blue raster with the control disc until the raster is centered on the CRT faceplate.

Press **ENTER** to continue with the CRT projection angle adjustment

ENTER continues to CRT Projection angle Adjustment.
EXIT returns to Optical focusing.
ADJUST returns to operational mode.

CRT projection angle adjustment

The projection angle of the red and blue CRT's is dependent on the desired size of the projected image. If the centers of green, blue and red do not coincide, the CRT projection angle must be adjusted. Never try to correct this misalignment with the shift correction or the static convergence controls. These controls may only be applied to correct small errors which cannot be corrected by the CRT angle adjustment.

Ensure that the rasters are centered on the CRT face.

Press **ENTER** to start the CRT angle adjustment procedure. A crosshairs (green and red) will be displayed on the screen. **ENTER** continues to the crosshairs alignment.

EXIT returns to raster shift adjustment
ADJUST returns to operational mode.

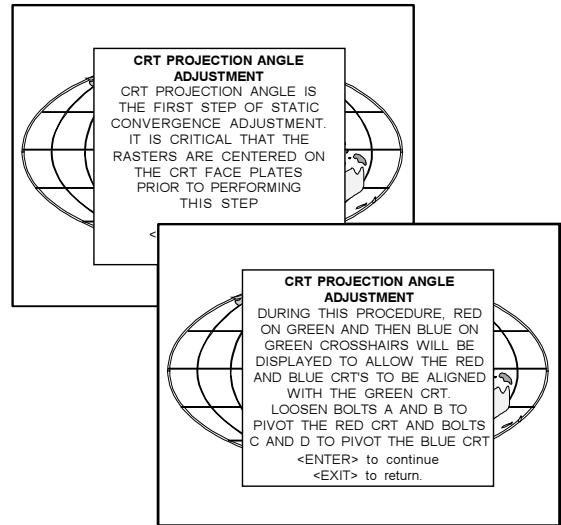

Projection angle correctly aligned for screen width SW1

The same projection angle is mis-aligned for new screen width SW2. Re-alignment is necessary. Each screen width change requires readjustment of the projection angle.

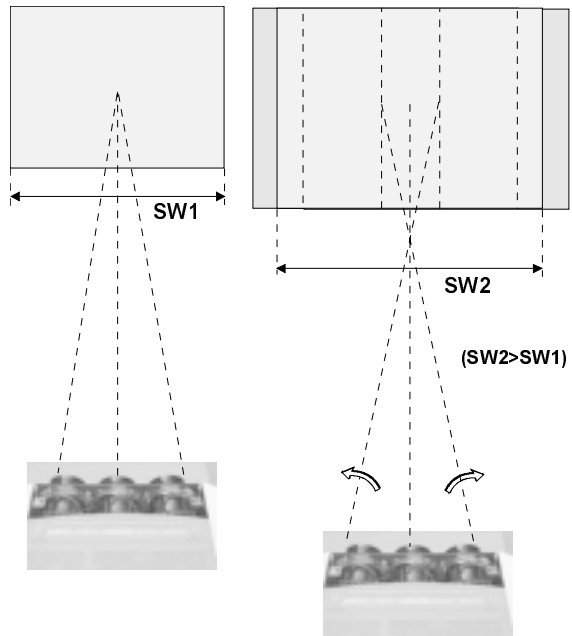

Screws A, B, C and D (M4) : upper fixation latch. nutdriver 7mm.
 Screw A', B', C' and D' (M4) : lower fixation latch. nutdriver 7mm.

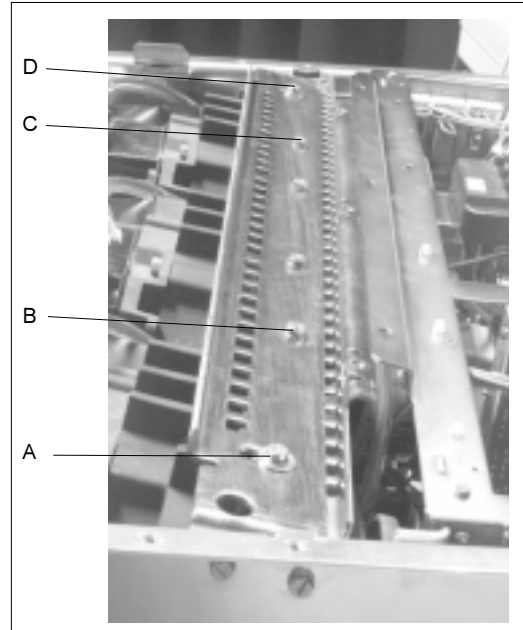

Loosen the two hexagon screws A and A' upper and lower fixation latch. These screws fasten the cooling house of the red tube. Pivot the red CRT until the center of the red image coincides with the center of the green image. If the tube is hard to pivot, loosen also screw B a little bit. If the angle of the red CRT is corrected, tighten the bolts again.

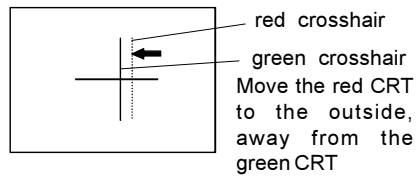
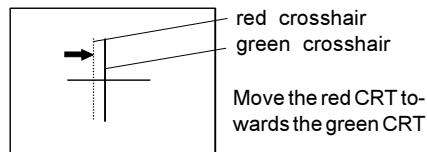

ENTER continues to blue and green crosshairs.
EXIT will return to CRT projection angle adjustment.

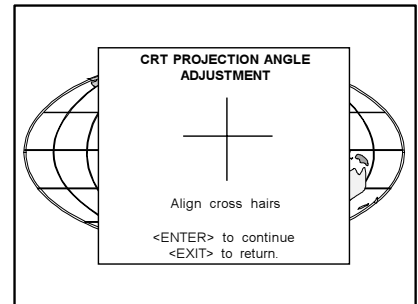

Loosen the two hexagon screws D and D' upper and lower fixation latch. These screws fasten the cooling house of the red tube. Pivot the red CRT until the center of the red image coincides with the center of the green image. If the tube is hard to pivot, loosen also screw C a little bit. If the angle of the red CRT is corrected, tighten the bolts again.

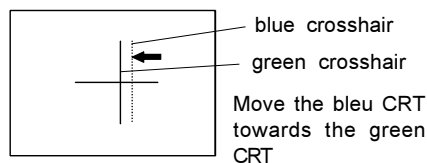
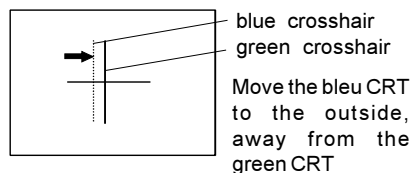

ENTER continues to the path selection menu.
EXIT returns to the CRT projection angle adjustment.

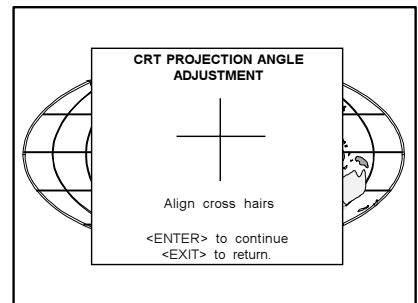

Installation Adjustments

After finishing the installation adjustments procedure, the 'Path selection' returns on the screen. You are now able to start the alignment procedure for the projector. You have the choice between:

- Guided Adjustment Procedure
- Random Access Adjustment Procedure

The result of both procedures will be the same. More explanation about both procedures is given in the owners manual.

The following paragraph gives an overview of the image corrections.

Alignment of the projector.

Overview of the corrections

For detailed information about these corrections and procedures to be followed, see owner's manual. (pages given hereafter are for the random access adjustment mode)

Shift corrections for the Red, Green and Blue image.

Left-Right adjustments

- Vertical center line bow and skew
- Left and right keystone adjustment
- Left and right bow adjustment
- Horizontal size adjustment

Top-Bottom adjustments

- Horizontal centerline bow and skew
- Top keystone adjustment
- Top bow adjustment
- Bottom keystone adjustment
- Bottom bow adjustment

Size-linearity adjustments

- Horizontal size adjustment
- Vertical linearity adjustment
- Vertical size adjustment
- Horizontal phase adjustment

Convergence adjustments

- Green only
- Red on green
- Blue on green

Blanking adjustment

- Top-Bottom, Left-Right

Color adjustments

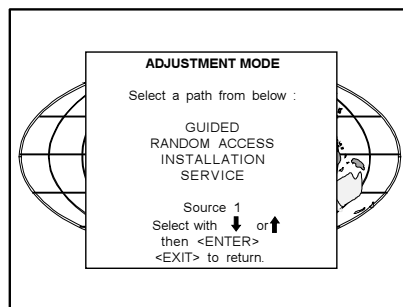

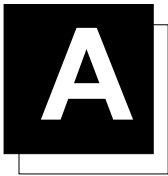

G2 ADJUSTMENT

G2 adjustment

Enter the adjustment mode by pressing **ADJUST** and highlight **Service**. Press **ENTER** to start up the service mode.

Highlight 'Common settings' and press **ENTER**.

ENTER starts up the Common settings menu.
EXIT returns to the adjustment mode menu.

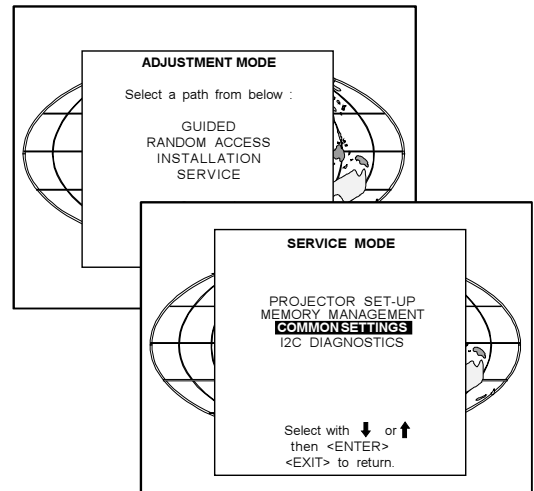

Highlight G2 adjust and press **ENTER**.

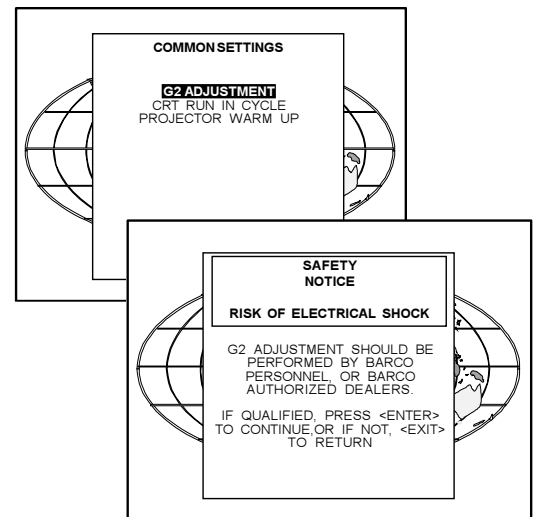

A safety notice will be displayed to warn the operator.

If you are qualified, press **ENTER** to continue with the G2 adjustment, otherwise press **EXIT** to return to the service menu.

If **ENTER** is pressed, the G2 menu will be displayed.

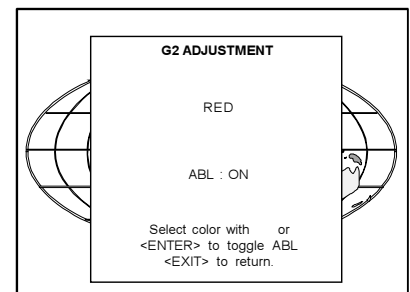

Open the top cover to reach the G2 controls and adjust these G2 controls for Red, Blue and Green separately.

Look to the projected image and observe the raster behind the image while the ABL function is ON.

Switch the ABL to OFF by pressing **ENTER** and adjust the G2 control until the raster brightness looks the same as when the ABL function is ON.

Check the correct raster adjustment by pressing **ENTER** to toggle ABL to ON. Repeat these steps if necessary.

G2 Adjustment

Continue with the other colors. Use the right or left arrow key to select the next color.

Note : The best result is obtained in a completely dark room or by looking into the lenses, but be aware that brightness and contrast are on a high level.