

NEC Technologies, Inc.
1255 Michael Drive
Wood Dale, Illinois 60191

NEC

Printed in Japan
79TM0282

NEC Improved Definition Converter IDC-3000

NEC Improved Definition Converter IDC-3000

MultiSync[®]

User's Manual

NEC

WARNING

TO PREVENT FIRE OR SHOCK HAZARDS, DO NOT EXPOSE THIS UNIT TO RAIN OR MOISTURE. ALSO DO NOT USE THIS UNIT'S POLARIZED PLUG WITH AN EXTENSION CORD RECEPTACLE OR OTHER OUTLETS, UNLESS THE PRONGS CAN BE FULLY INSERTED. REFRAIN FROM OPENING THE CABINET AS THERE ARE HIGH VOLTAGE COMPONENTS INSIDE. REFER SERVICING TO QUALIFIED SERVICE PERSONNEL.

AVERTISSEMENT

AFIN D'EVITER TOUT RISQUE D'INCENDIE OU D'ELECTROCUTION, NE PAS EXPOSER CET APPAREIL A LA PLUIE OU A L'HUMIDITE. DE MEME, NE PAS UTILISER CETTE FICHE POLARISEE AVEC UN PROLONGATEUR, UNE PRISE DE COURANT OU UNE AUTRE SORTIE DE COURANT SAUF SI CES LAMES PEUVENT ETRE INSEREES A FOND SANS EN LAISSER AUCUNE PARTIE A DECOUVERT. EVITER D'OUVRIER LE COFFRET, CAR IL Y A, A L'INTERIEUR, DES COMPOSANTS SOUMIS A UNE HAUTE TENSION. POUR LES REPARATIONS, S'ADRESSER A UN PERSONNEL QUALIFIE.



CAUTION

RISK OF ELECTRIC SHOCK
DO NOT OPEN



CAUTION: TO REDUCE THE RISK OF ELECTRIC SHOCK, DO NOT REMOVE COVER. NO USER-SERVICEABLE PARTS INSIDE. REFER SERVICING TO QUALIFIED SERVICE PERSONNEL.



This symbol warns the user that uninsulated voltage within the unit may have sufficient magnitude to cause electric shock.

Therefore, it is dangerous to make any kind of contact with any part inside of this unit.



This symbol alerts the user that important literature concerning the operation and maintenance of this unit has been included.

Therefore, it should be read carefully in order to avoid any problems.



ATTENTION

RISQUE D'ELECTROCUTION
NE PAS OUVRIR



ATTENTION: AFIN D'EVITER TOUT RISQUE D'ELECTROCUTION, NE PAS ENLEVER LE COUVERCLE. AUCUN DES ELEMENTS INTERNES NE DOIT ETRE REPARÉ PAR L'UTILISATEUR. NE CONFIER L'ENTRETIEN QU'À UN PERSONNEL QUALIFIÉ.



La flèche symbolisant le tonnerre à l'intérieur du triangle équilatéral a pour but de prévenir l'utilisateur de la présence d'une tension dangereuse non isolée se trouvant à l'intérieur du dispositif: elle est d'une intensité suffisante pour constituer un risque d'électrocution.



Le point d'exclamation du triangle équilatéral a pour but de prévenir l'utilisateur de la présence d'importantes instructions concernant l'entretien et le fonctionnement, indiquées dans la brochure accompagnant l'appareil. Par conséquent, elles doivent être lues attentivement afin d'éviter des problèmes.

DOC Compliance Notice

This Class B digital apparatus meets all requirements of the Canadian Interference-Causing Equipment Regulations.

DOC avis de conformation

Cet appareil numérique de la classe B respecte toutes les exigences du Règlement sur le Matériel Brouilleur du Canada.

• WARNING •

This equipment has been tested and found to comply with the limits for a Class B digital device, pursuant to Part 15 of the FCC Rules. These limits are designed to provide reasonable protection against harmful interference in a residential installation. This equipment generates, uses, and can radiate radio frequency energy and, if not installed and used in accordance with the instructions, may cause harmful interference to radio communications. However, there is no guarantee that interference will not occur in a particular installation. If this equipment does cause harmful interference to radio or television reception, which can be determined by turning the equipment off and on, the user is encouraged to try to correct the interference by one or more of the following measures:

- Reorient or relocate the receiving antenna.
- Increase the separation between the equipment and receiver.
- Connect the equipment into an outlet on a circuit different from that to which the receiver is connected.
- Consult the dealer or an experienced radio/TV technician for help.

CONTENTS

FEATURES	1	ON-SCREEN DISPLAY	18
WARNINGS AND PRECAUTION	2	HOOK-UP EXAMPLES	26
PART NAMES AND FUNCTIONS	4	<i>Using the EXTERNAL CONTROL Connector</i>	28
FRONT PANEL	4	<i>Using the PC-CONTROL Connector</i>	29
INDICATORS	6	RACK MOUNTING	32
REAR PANEL	8	SPECIFICATIONS	34
REMOTE CONTROL	12	APPENDIX	36
REMOTE CONTROL NOTES	14	LIMITED WARRANTY	40
ADJUSTMENT	16		

The IDC-3000 converts NTSC video signals into scan-doubled signals. This scan converter can be used with a multi-synchronous scan monitor or projectors having a minimum of 31.5 kHz horizontal scanning capability to provide high-quality images.

The IDC-3000 can be also connected to a document camera, conventional VCR, video disc player, S-Video recorder, or video camera.

FEATURES

- Motion adaptive 3-dimensional Y/C separation circuit greatly reduces cross talk (dot interference/cross color).
- Motion adaptive 3-dimensional scanning line interpolation circuit provides a reduction of line flicker and an increase of vertical resolution.
- Two-mode digital video noise reduction circuit greatly improves the signal-to-noise ratio of the signal.
- Forced (non adaptive) still screen mode provides a still image without erroneous operation of the operation detection circuit. (This is useful with the images of document cameras, etc.)
- Equipped with a demonstration split function for processing artificial interlace and switching off 3-dimensional Y/C separation processing the right half of the screen.
- PC-CONTROL connector permits control of a personal computer.

Warnings and Safety Precaution

The NEC IDC-3000 is designed and manufactured to provide long, trouble-free service. No maintenance other than cleaning is required. Use a soft cloth and if necessary, mild detergent. Do not use commercial spray cleaners which may damage the surface. In case of damage, arrange for repairs at an authorized NEC Service Center.

For operating safety and to avoid damage to the unit, read carefully and observe the following instructions.

To avoid shock and fire hazards:

1. Provide adequate space for ventilation to avoid internal heat build-up. If you enclose the unit in a cabinet or rack, be sure there is adequate space at the top of the unit to allow heated air to rise and escape.
2. Do not use the power cord polarized plug with extension cords or outlets unless the prongs can be completely inserted.
3. Do not expose unit to rain or moisture.
4. Avoid damage to the power cord, and do not attempt to modify the power cord.
5. Unplug unit during electrical storms or if unit will not be used over a long period.
6. Do not open the cabinet which has potentially dangerous high voltage components inside. If the unit is damaged in this way the warranty will be void. Moreover, there is a serious risk of electric shock.

Mises en garde et précautions de sécurité

Le IDC-3000 NEC a été conçu et fabriqué pour assurer une longue durée de service sans problèmes. Aucun entretien à l'exception du nettoyage n'est nécessaire. Utiliser un chiffon doux et un détergent doux, si nécessaire. Ne pas utiliser des aérosols de nettoyage du commerce qui risquent d'endommager la surface de cet appareil. Si l'appareil est endommagé, confier les travaux de réparation à un centre de service agréé NEC.

Pour un fonctionnement sûr et afin d'éviter d'endommager l'appareil, lire attentivement et respecter les instructions suivantes.

Afin d'éviter tout risque d'électrocution et d'incendie:

1. Réserver un espace libre suffisant pour la ventilation afin d'éviter une accumulation de chaleur interne. Si l'appareil est logé dans un coffret ou sur une étagère, s'assurer qu'il y a un espace libre suffisant pour la dissipation de la chaleur.
2. Ne pas utiliser la fiche polarisée du cordon d'alimentation avec des prolongateurs ou des prises de courant, sauf si les lames peuvent être insérées à fond.
3. Ne pas exposer à la pluie ou à l'humidité.
4. Éviter d'endommager le cordon d'alimentation, et ne pas modifier le cordon d'alimentation.
5. Débrancher l'appareil pendant les tempêtes ou si l'appareil n'est pas utilisé pendant une longue période.
6. Ne pas ouvrir le coffret. Des composants de haute tension se trouvent à l'intérieur. Si l'appareil est endommagé de cette manière, la garantie devient caduque. De plus, il y a un risque d'électrocution.

7. Do not attempt to service or repair the unit. NEC is not liable for any bodily harm or damage caused if unqualified persons attempt service or open the cabinet. Refer all service to authorized NEC Service Centers.

To avoid damage and prolong operating life:

1. Use only with 120V 60Hz AC power supply.
2. Handle the unit carefully when moving and do not drop.
3. Locate set away from heat, excessive dust, and direct sunlight.
4. Protect the inside of the unit from liquids and small metal objects. In case of accident, unplug the unit and have it serviced by an authorized NEC Service Center.
5. Unplug unit before cleaning. Use only a soft cloth and mild detergent. Commercial household sprays and cleaners may damage the cabinet.

WARNING

Unqualified persons should under no circumstances remove the cabinet of the unit to make internal adjustments. The warranty is void if the unit is damaged in this way. Moreover, there is a serious risk of electric shock. If you have service difficulties, call your dealer.

7. Ne pas essayer de réparer ou entretenir l'appareil soi-même. NEC ne saura être tenu pour responsable pour toute blessure ou dommage causé par des personnes non qualifiées qui essaient de réparer ou d'ouvrir le coffret. Confier toute réparation à un centre de service agréé NEC.

Pour éviter des dommages et prolonger la durée de service de l'appareil:

1. N'utiliser qu'une source d'alimentation de 120 V 60 Hz CA.
2. Manipuler l'appareil avec soin pendant son déplacement et ne pas le faire tomber.
3. Eloigner l'appareil des endroits chauds, très poussiéreux et exposés en plein soleil.
4. Éviter que des liquides et des petits objets métalliques pénètrent à l'intérieur de l'appareil. En cas d'accident, débrancher l'appareil et le confier à un centre de service agréé NEC.
5. Débrancher l'appareil avant le nettoyage. Utiliser seulement un chiffon doux et un détergent doux.
Des aérosols et produits de nettoyage disponibles dans le commerce risquent d'endommager le coffret.

AVERTISSEMENT

Le coffret ne doit pas être enlevé par un personnel non qualifié pour faire les réglages internes. La garantie devient caduque si l'appareil est endommagé de cette manière. De plus, il y a un risque d'électrocution. En cas de problèmes de réparation contacter votre revendeur.

PART NAMES AND FUNCTIONS

FRONT PANEL

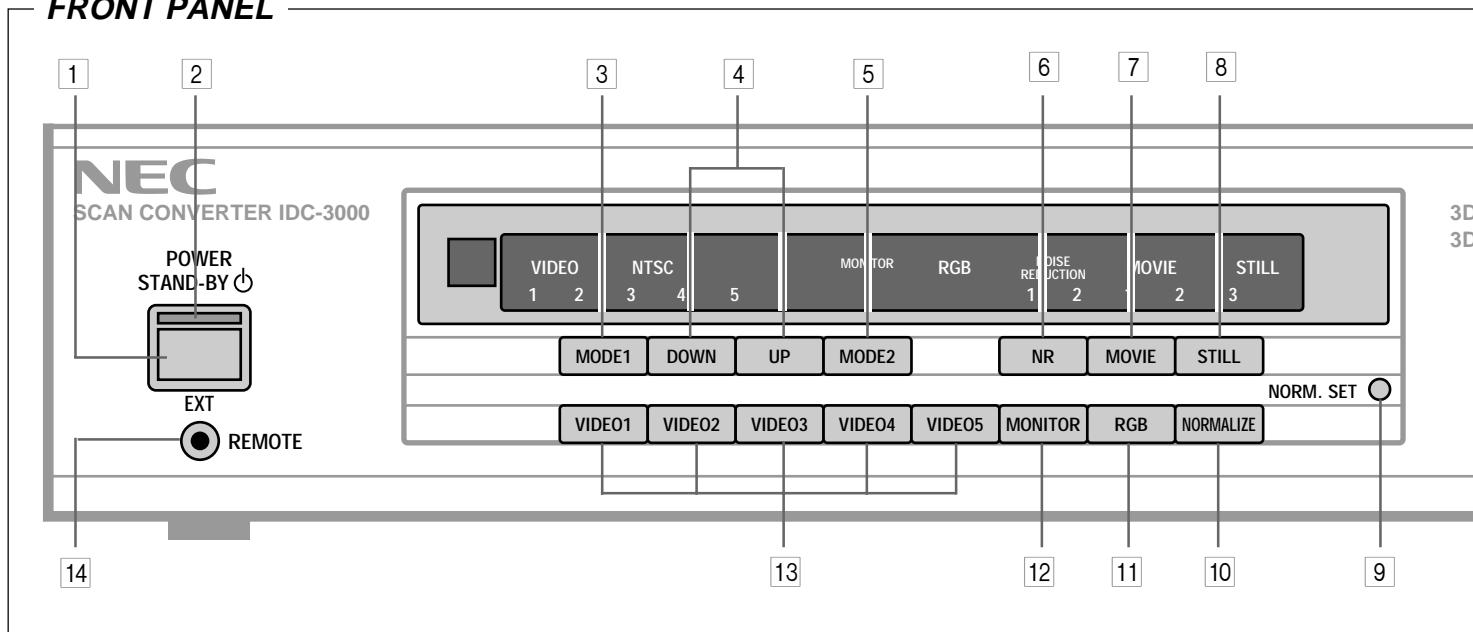

1 POWER Button

Press to turn the unit on when the power cord is connected to an active AC power outlet.

NOTE: After the power cord is connected to an active power outlet, the unit enters the standby mode, and the red STAND-BY indicator is illuminated.

In this mode the unit can be turned on by pressing the POWER button. The STAND-BY indicator changes to green to show that the unit is turned on.

2 POWER / STAND-BY Indicator

Indicator LED is green when the unit is turned on. When the unit is turned off, this indicator is red and the unit enters the standby mode. During external control, the indicator is amber when the unit is turned on.

3 MODE 1 Button

Selects image adjustment and audio adjustment. Each time this button is pressed, mode 1 will change as follows:

→ COLOR → TINT → SHARPNESS → SOUND

4 DOWN and UP Buttons

Used to adjust the item selected with the MODE 1 or MODE 2 button.

5 MODE 2 Button

Used to select the image system. Each time this button is pressed, mode 2 will change as follows:

→ SPLIT → MOVIE

- **SPLIT** Selects the demonstration split mode function for processing the artificial interlace and switching off the 3-dimensional Y/C separation processing the right half of the screen.

NOTE: The demonstration split mode function is available for the NTSC signal only.

NOTE: Even though the NTSC indicator may not illuminate for sub-standard NTSC signals such as poor quality video signals, the split screen will still function. However, the demonstration split mode function has less effect because the 3-dimensional Y/C separation processing is not performed unless the NTSC indicator is lit.

- **MOVIE** Selects the Y/C separation method and the image interpolation method.

Mode	Y/C Separation	Image Interpolation
Normal	Motion adaptation	Motion adaptation
Movie 1	Move mode	Move mode
Movie 2	Move mode	Motion adaptation
Movie 3	Motion adaptation	Move mode

INDICATORS

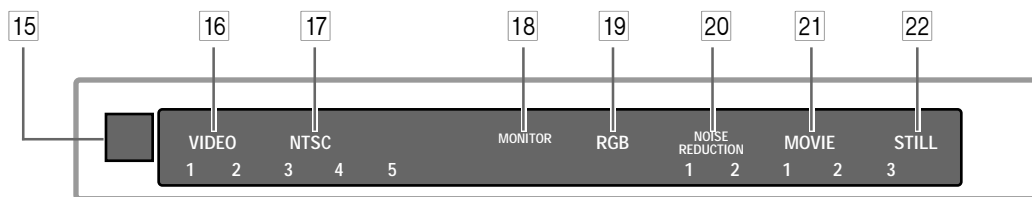

6 NR Button

Used when screen noise becomes annoying. Each time this button is pressed, the NR function will change as follows:

→ OFF → NOISE REDUCTION1 → NOISE REDUCTION 2
(Noise is reduced) (Noise is further reduced)

7 MOVIE Button

Press to manually set the method of Y/C separation and image interpolation.

8 STILL Button

Press to display still images such as those from document cameras, etc. The Y/C separation and image interpolation will be set for the still screen mode.

12 MONITOR Button

Switches the MONITOR OUT jack output at the time of RGB input. Each time this button is pressed, the MONITOR OUT jack output will change as follows:

→ VIDEO1 → VIDEO2 → VIDEO3 → VIDEO4 → VIDEO5 → OFF

13 VIDEO 1 through 5 Button

Switches the video input mode.

14 REMOTE Jack

For service personnel only.

15 Remote Sensor Window

Receives the signal from the wireless remote control.

16 VIDEO 1, 2, 3, 4, 5 Indicator

Lights when the unit is switched to the video input mode with the VIDEO 1 through 5 buttons.

17 NTSC Indicator

Lights when an NTSC standard signal is received. IDTV processing is in operation when this indicator is lit.

9 NORM. SET Switch

This is an adjustment switch for service personnel.

10 NORMALIZE Button

Sets the various adjustments to the standard settings (which had been set at the factory prior to shipping).

11 RGB Button

Switches the unit to the RGB input mode.

18 MONITOR Indicator

Lights when the MONITOR OUT output is selected at the time of RGB input.

19 RGB Indicator

Lights when the unit is switched to the RGB input mode with the RGB button.

20 NOISE REDUCTION 1 and 2 Indicators

Indicate the mode selected with the NR button.

21 MOVIE 1, 2 and 3 Indicators

Indicate the mode selected with the MOVIE button.

22 STILL Indicator

Lights when the STILL button is switched on.

REAR PANEL

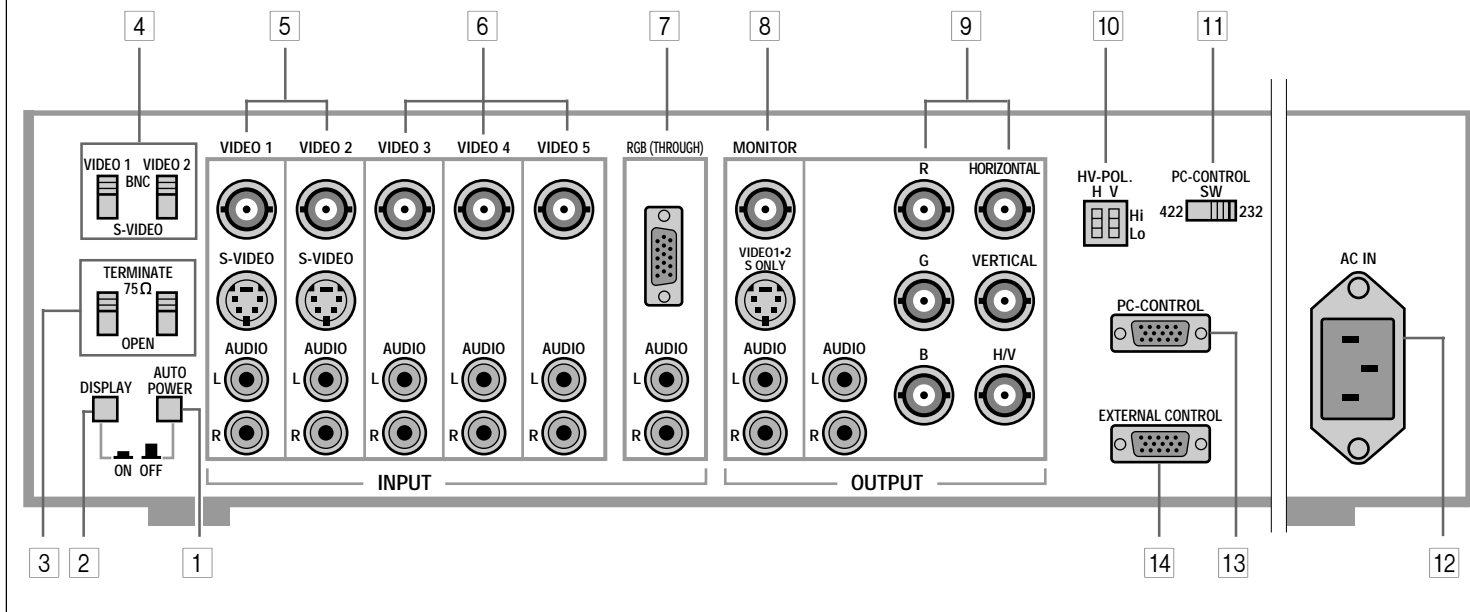



1 AUTO POWER Switch

ON START The power is automatically switched on when the power cord is connected to the power outlet.
()
(It is not necessary to press the front panel POWER button.)

OFF START ... After connecting the power cord to the power outlet, a press of the front panel POWER button will switch on the power.
()

2 DISPLAY Switch

ON () On-screen display will appear on the monitor.
OFF () On-screen display will not appear on the monitor.

3 TERMINATE Switch (VIDEO 1 and VIDEO 2)

Switches the terminating resistor of the BNC input jacks.
75Ω 75Ω termination input
OPEN High impedance input

4 BNC/S-VIDEO Switch (VIDEO 1 and VIDEO 2)

BNC Provides the appropriate switching when the signal is input from the BNC input jacks.
S-VIDEO Provides the appropriate switching when the signal is input from the S-VIDEO input jack.

5 VIDEO 1 and VIDEO 2 Input Jacks (INPUT)

VIDEO 1 and 2 (BNC) Connected with the video output jacks of the external equipment.
S-VIDEO Connected with the S-video output jack of the external equipment.
AUDIO L and R (RCA) ... Connected with the audio output jacks of the external equipment.

6 VIDEO 3, VIDEO 4, and VIDEO 5 Input Jacks (INPUT)

VIDEO 3, 4, and 5 (BNC) Connected with the video output jacks of the external equipment.
AUDIO L and R (RCA) ... Connected with the audio output jacks of the external equipment.

7 RGB Input Connector (THROUGH)

RGB (D-sub 15 miniature) Connected with the RGB output connector of the external equipment. The input signal is through-output from the RGB output connector. See page 11 for pin assignment.

8 MONITOR Output Jack (OUTPUT)

- MONITOR (BNC) Outputs the signals of the equipment connected to VIDEO 1 through 5.
- S-VIDEO Outputs an S video signal, (derived from the signal of the equipment connected to VIDEO 1 or VIDEO 2), which has been divided to a luminance signal (Y) and a chrominance signal (C).
- AUDIO L and R (RCA) ... Outputs the signal of the equipment connected to VIDEO input 1 through 5 and the AUDIO L and R associated with the RGB input connector.
The selected video signal is output when RGB input has been selected and MONITOR button is switched on.

9 RGB Output Connector (OUTPUT)

- RGB (BNC) Connected to the RGB input jacks of a monitor or projector having a 31.5 kHz horizontal scanning function.
- HORIZONTAL (BNC) Connected to the HORIZONTAL input jack of a monitor or projector having a 31.5 kHz horizontal scanning function.
- VERTICAL (BNC) Connected to the VERTICAL input jack of a monitor or projector having a 31.5 kHz horizontal scanning function.

14 EXTERNAL CONTROL Connector

Connections are made to this connector when controlling this unit by external control.
(See the “External Control Mode” section.)

NOTE :

- Use a signal conforming to the standard TV signal when connecting an input source.
- Using poor quality video tape may cause distortion on the picture.

- H/V (BNC) Connected to the H/V input jack of a monitor or projector having a 31.5 kHz horizontal scanning function.
- AUDIO L and R (RCA) ... Connected to the audio input jacks of RGB equipment.

10 HV POL. Switch

- Selects the polarity of the horizontal and vertical output signals.
- H Horizontal
- V Vertical
- Hi Active high
- Lo Active low

11 PC-CONTROL SW (Switch)

- Selects the communications standard of the PC-CONTROL connector.
- 422 RS-422 standard
- 232 RS-232C standard

12 AC IN Receptacle

Used to connect the supplied power cord.

13 PC-CONTROL Connector (15-pin connector)

Connect to a personal computer or other control equipment.

RGB (D-Sub 15 mini) Connector Pin Assignment

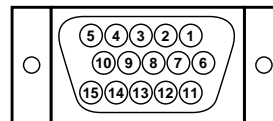

Pin No.	Signal to be connected
1	Red input
2	Green input
3	Blue input
4	GND
5	GND
6	Red GND
7	Green GND
8	Blue GND
9	Open
10	Sync GND
11	GND
12	Open
13	H-Sync
14	V-Sync
15	Open

REMOTE CONTROL

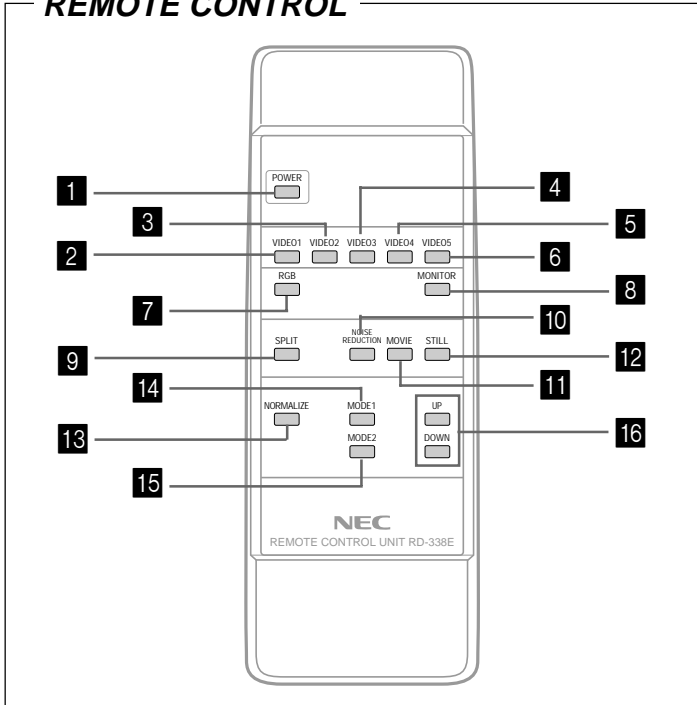

1 POWER Button

Turns the power on or off.

2 VIDEO 1 Button

Switches the unit to the video 1 input mode.

3 VIDEO 2 Button

Switches the unit to the video 2 input mode.

4 VIDEO 3 Button

Switches the unit to the video 3 input mode.

5 VIDEO 4 Button

Switches the unit to the video 4 input mode.

6 VIDEO 5 Button

Switches the unit to the video 5 input mode.

7 RGB Button

Switches the unit to the RGB input mode.

8 MONITOR Button

Used to switch on the monitor mode at the time of RGB input.

9 SPLIT

Press to activate the demonstration split mode function for processing the artificial interlace and switching off the 3-dimensional Y/C separation processing the right half of the screen.

This function is for use when the NTSC indicator is lit.

10 NOISE REDUCTION Button

Used when screen noise becomes annoying. Each time this button is pressed, the NR function will change as follows:

→ OFF → **NOISE REDUCTION 1** → **NOISE REDUCTION 2**
 (Noise is reduced) (Noise is further reduced)

11 MOVIE Button

Press to manually set the method of Y/C separation and image interpolation.

12 STILL Button

Press to display still images such as those from document cameras, etc. The Y/C separation and image interpolation will be set for the still screen mode.

13 NORMALIZE Button

Sets the various adjustments to the standard settings (which had been set at the factory prior to shipping).

14 MODE 1 Button

Selects image adjustment and audio adjustment. Each time this button is pressed, mode 1 will change as follows:

→ **COLOR** → **TINT** → **SHARPNESS** → **SOUND**

15 MODE 2 Button

Used to select the image system. Each time this button is pressed, mode 2 will change as follows:

→ **SPLIT** → **MOVIE**

- **SPLIT** Selects the demonstration split mode function for processing the artificial interlace and switching off the 3-dimensional Y/C separation processing the right half of the screen.

This function is for use when the NTSC indicator is lit.

- **MOVIE** Selects the Y/C separation method and the image interpolation method.

Mode	Y/C Separation	Image Interpolation
Normal	Motion adaptation	Motion adaptation
Movie 1	Move mode	Move mode
Movie 2	Move mode	Motion adaptation
Movie 3	Motion adaptation	Move mode

16 DOWN and UP Buttons

Used to adjust or activate the item selected with the MODE 1 or MODE 2 button.

REMOTE CONTROL NOTES

Remote Control Precautions

- The remote control system may not function when direct sunlight or strong illumination strikes the remote sensor window of the main unit.
- Do not place in locations where there is a high temperature or high humidity. Doing so will lead to breakdown.
- When remote control buttons are pressed and held, main unit operations may not be possible.

Installing the Batteries of the Remote Control

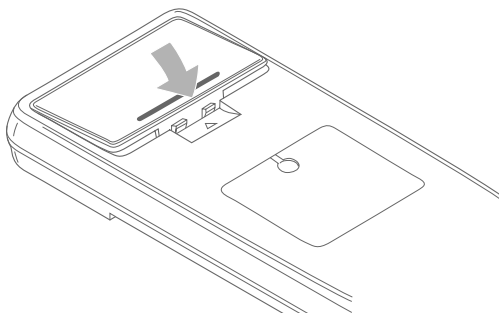
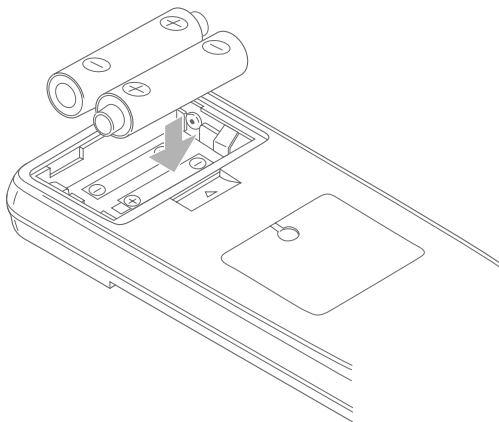
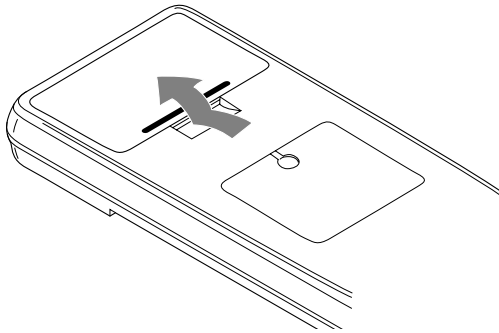

Battery Precautions

- Do not use new and old batteries together.
- Do not use different kinds of batteries together.
- Do not short-circuit batteries, heat them, or throw them into a fire.
- Do not take apart the batteries.
- Remove the batteries from the remote control when the remote control is not going to be used for a long period.

1 Press and open the cover in the direction of the arrow.

2 Install the batteries according to the + and - indications inside the case.

3 Close the cover.

NOTE :

Use two 1.5V "AA" batteries when replacing the batteries.

ADJUSTMENT

Adjustment of COLOR, TINT, SHARPNESS, and SOUND

- (1) Press the MODE 1 button and select the mode to be adjusted.
Each press of the MODE 1 button will change the selection as follows:



- (2) While the indicator is on, press and hold the UP or DOWN button and adjust.
COLOR Adjusts the density of the color.
TINT Adjusts the tint.
SHARPNESS Adjusts the sharpness of the picture quality.
SOUND Adjusts the output level of the audio.

MOVIE

Use the UP and DOWN buttons to select the movie mode.



UP button → Changes clockwise
 DOWN button ← Changes counterclockwise

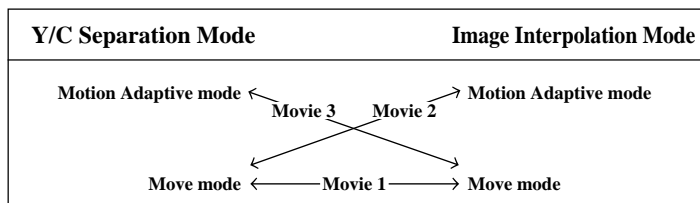

The MOVIE mode functions only when the MOVIE indicator of the front panel is lit.

Adjustment of SPLIT and MOVIE

Press the MODE 2 button and select the mode to be adjusted.
Each press of the MODE 2 button will change the selection as follows:

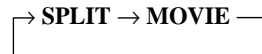

While the indicator is on, press the UP or DOWN button and adjust.

SPLIT

Split on UP button or SPLIT button
 Split off DOWN button or SPLIT button

SPLIT On

Sets the demonstration split mode function for processing the artificial interlace and switching off the 3-dimensional Y/C separation processing the right half of the screen.

This function is for use when the NTSC indicator is lit.

NOTE : Processing is done to a Y/C separated signal. For this reason, Y/C separation mode is not effective when S-VIDEO input selected.

NOTE : Each adjustment is available only when the on-screen appears.

NOTE : Processing is done to a Y/C separated signal. For this reason, Y/C separation mode is not effective when S-VIDEO input selected.

ON-SCREEN DISPLAY

Screen Display During Input Signal Selection



Display characters during video 1 to 5 input signal selection

During video 1 input signal selection SOURCE VIDEO 1
 During video 1 S input signal selection SOURCE S-VIDEO 1
 During video 2 input signal selection SOURCE VIDEO 2
 During video 2 S input signal selection SOURCE S-VIDEO 2
 During video 3 input signal selection SOURCE VIDEO 3
 During video 4 input signal selection SOURCE VIDEO 4
 During video 5 input signal selection SOURCE VIDEO 5

Display color All yellow

Screen Display During DVNR (Noise Reduction) Selection



Display characters during noise reduction selection

During Noise reduction 1 selection DVNR 1
 During Noise reduction 2 selection DVNR 2

Display color All cyan

Screen Display During STILL Mode Selection

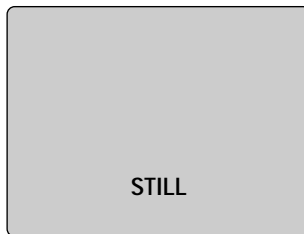

Display characters during still mode selection

Display color

STILL cyan

Screen Display During Split Mode Selection

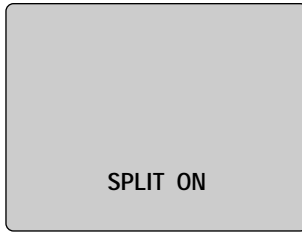

Display characters during split mode selection in mode 2

During split selection SPLIT ON
 When split is not selected SPLIT OFF

Display color

SPLIT ON Cyan
 SPLIT OFF Cyan

Screen Display During MOVIE Mode Selection

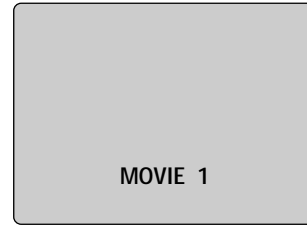

Display characters during movie mode selection

During movie mode 1 selection MOVIE 1
 During movie mode 2 selection MOVIE 2
 During movie mode 3 selection MOVIE 3

Display color All cyan

Screen Display During NORMALIZED Selection

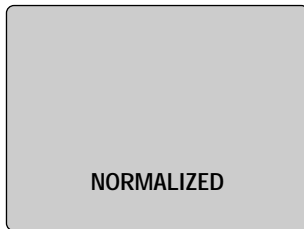

A press of the "NORMALIZED" button returns the value set in "MODE 1" to the initial setting value.

Display characters during normalize selection

Display color
 NORMALIZED Magenta

During the NTSC COLOR Adjustment

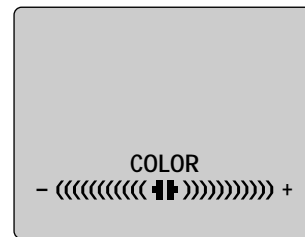

Display characters during the color adjustment

During NTSC COLOR

Display color

COLOR Green
 Bar Normal Magenta
 Max Red
 Min Blue

During the TINT (Center) Adjustment

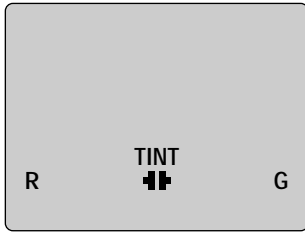

Display characters during the tint adjustment

Display color during the center adjustment

Tint Green
 R Red
 G Green
 ▬ Red
 ▬ Green

During the TINT (R Direction) Adjustment

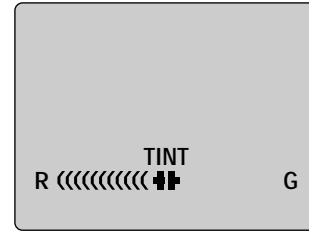

Display characters during the tint adjustment

Display color during the adjustment in the R direction

Tint Green
 R Red
 G Green
 ▬ Red

During the TINT (G Direction) Adjustment

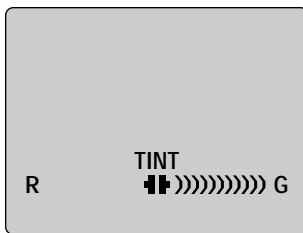

Display characters during the tint adjustment

Display color during the adjustment in the G direction

Tint Green
 R Red
 G Green
 ▬ Green

During the SHARPNESS Adjustment

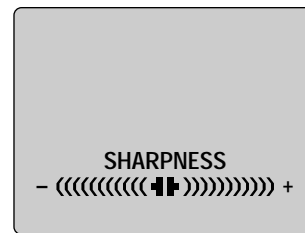

Display characters during the sharpness adjustment

Display color

SHARPNESS Green
 Bar Normal Magenta
 Max Red
 Min Green

During the SOUND Adjustment

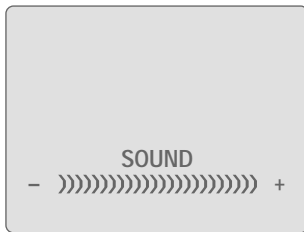

Display characters during the sound adjustment

Display color

SOUND	Green
Bar Normal	Magenta
Max	Red
Min	Blue

During the SPLIT Screen Selection

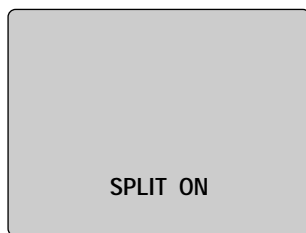

Display characters during the split mode selection

During split selection	SPLIT ON
When split is not selected	SPLIT OFF

Display color

SPLIT ON	Cyan
SPLIT OFF	Cyan

Screen Display During Mode 2 Adjustment

Each press of the “MODE 2” button changes the mode in a toggle operation, and selection is made with the “UP” and “SPLIT” button.

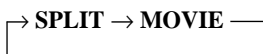

During the MOVIE Mode Selection

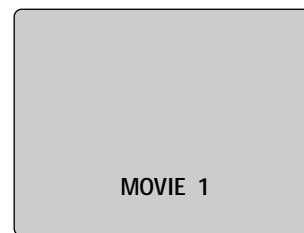

Display characters during the movie mode selection

During movie mode 1	MOVIE 1
During movie mode 2	MOVIE 2
During movie mode 3	MOVIE 3

Display color All Cyan

Screen Display During Mode 2 Adjustment

Each press of the “MODE 2” button changes the mode in a toggle operation, and selection is made with the “UP” and “DOWN” button.

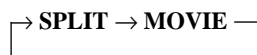

HOOK-UP EXAMPLES

Video equipment

Laser disc player or TV tuner

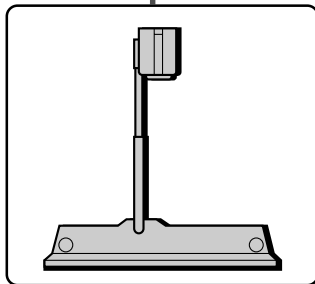
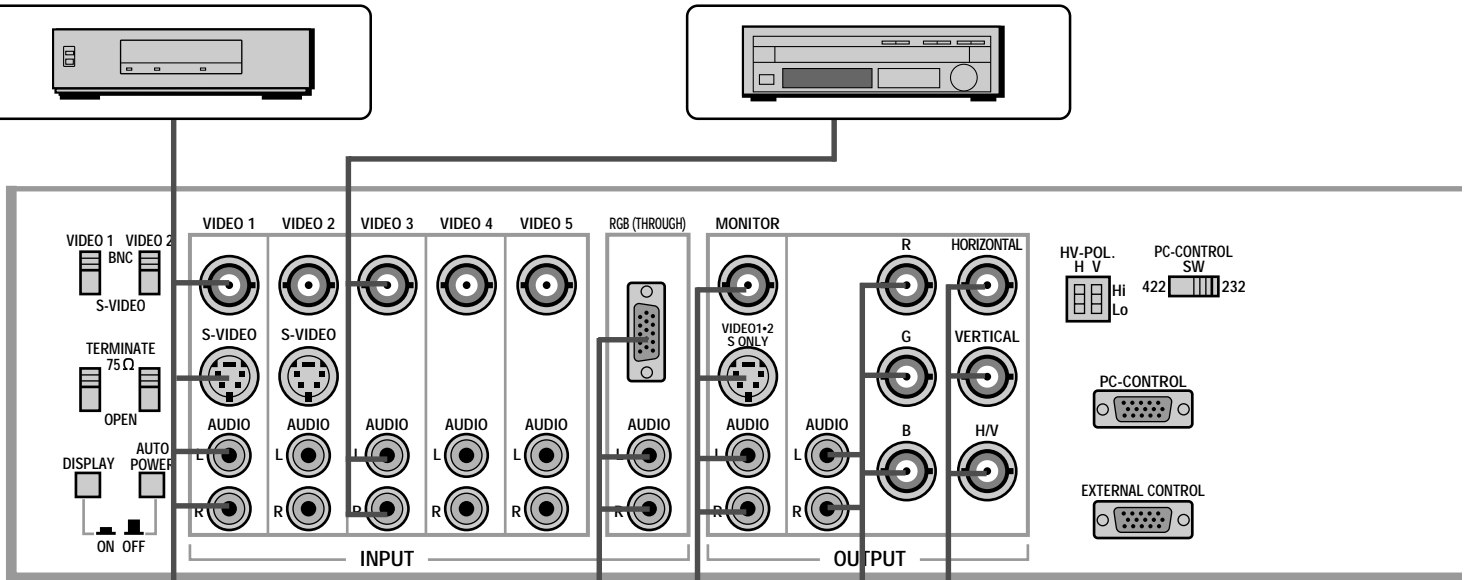

Video camera or document camera equipped with a VIDEO output or an S-VIDEO output.

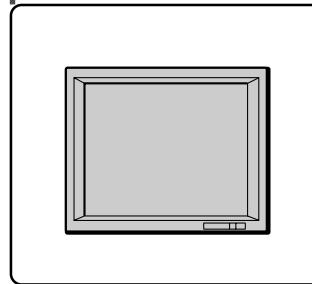

Video input of an NEC MultiSync monitor or an S-VIDEO input of a monitor.

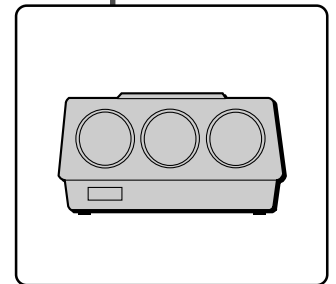

RGB inputs of projectors or monitors such as NEC MultiSync projector 9PG/6PG EXTRA, or PLUS, and NEC MultiSync multimedia monitor XP37/XM37 supporting a minimum of 31.5kHz horizontal scanning frequency.

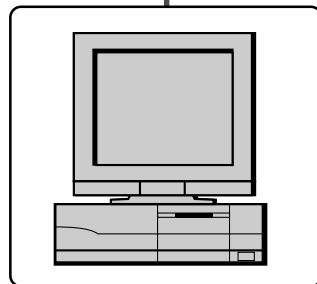

Personal computer

Using the EXTERNAL CONTROL Connector

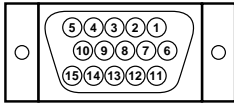

Mini D-SUB 15 Pin

Pin No.	Function
3	Input switching
5	Power on/off
8	Input switching
9	Input switching
14	External control on/off
15	Ground

NOTE: Button operations of the main unit and the remote control are not possible during use of external control.

Function Table

Function \ Pin No.	14-15	5-15	8-15	3-15	9-15	4-15
External control ON	SHORT					
External control OFF	OPEN					
POWER ON		SHORT				
POWER OFF		OPEN				
VIDEO 1			SHORT	SHORT	SHORT	
VIDEO 2			OPEN	SHORT	SHORT	
VIDEO 3			SHORT	OPEN	SHORT	
VIDEO 4			OPEN	OPEN	SHORT	
VIDEO 5			SHORT	SHORT	OPEN	
RGB			OPEN	OPEN	OPEN	

Using the PC-CONTROL Connector

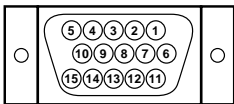

Mini D-SUB 15 Pin

NOTE: The communication mode of the PC-CONTROL terminal can be selected between RS-422 and RS-232C with the PC-CONTROL SW on the rear panel.

When using RS-232C, only pins 6,7,8 and 12 are effected. Therefore, nothing should be connected to pins 1,2,3 and 11. When using with a projector, set the PC-CONTROL switch to the 422 position.

PC-CONTROL Terminal

- Use the PC-CONTROL terminal when connecting to computers or other controllers.

Pin No.	I/O	Signal Name	Function
1	I	Receive Data+	Receiving data when using PC
6	I	Receive Data-	
2	O	Transmit Data+	Sending data when using PC
7	O	Transmit Data-	
11	I	Clear to Send+	Clearing to send when using PC
12	I	Clear to Send-	
3	O	Request to Send+	Requesting to send when using PC
8	O	Request to Send-	
9,13	O		Used inside the IDC-3000
4,5,10,14		No Connection	Not used
15		Signal Ground	Ground

PC is an abbreviation for personal computer.

Connection Examples for Personal Computer Control for the Two Variations.

① RS-232C



② RS-422

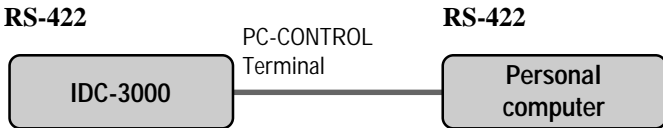

① When using the PC-CONTROL terminal as RS-232C:

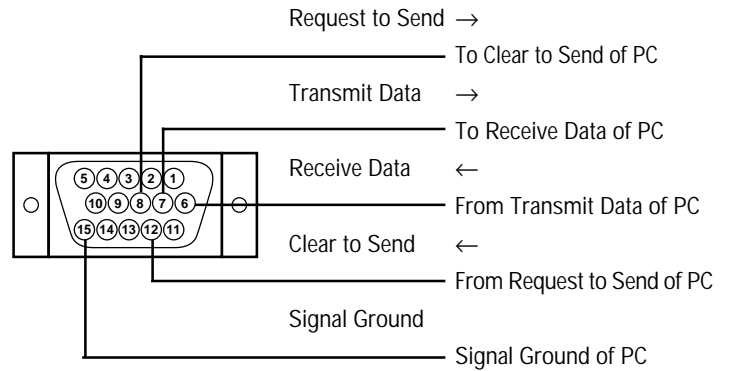

② When using the PC-CONTROL terminal as RS-422:

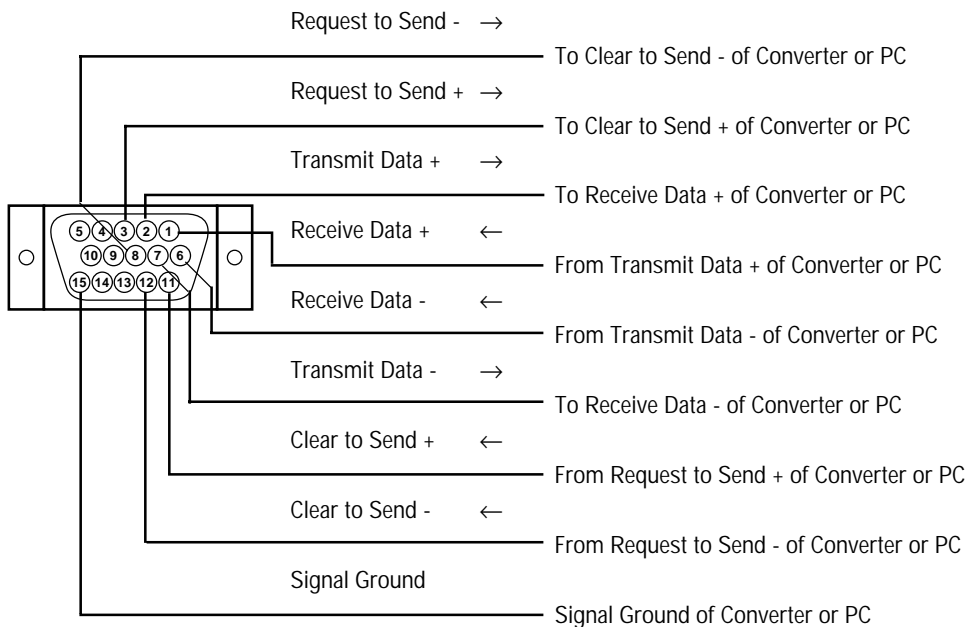

RACK MOUNTING

Use the accompanying rack mount bracket to mount the IDC-3000 to the rack.

NOTE: This rack mount bracket is designed for used with EIA standard racks.

1 Remove the four (A) screws from the IDC-3000.

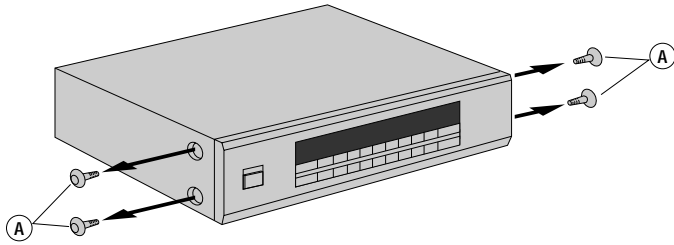

2 Use the screws removed in Step 1 to fasten the supplied rack mount bracket (B) to the IDC-3000.

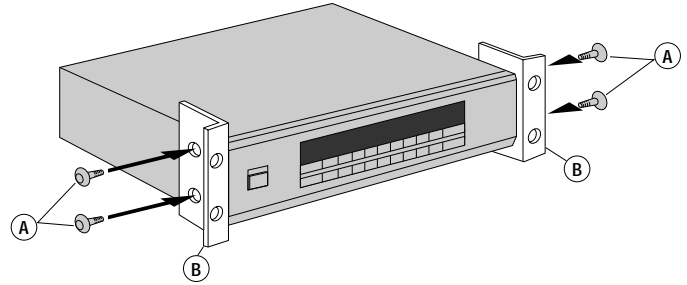

3 Mount the IDC-3000 to the rack and tighten the screws.

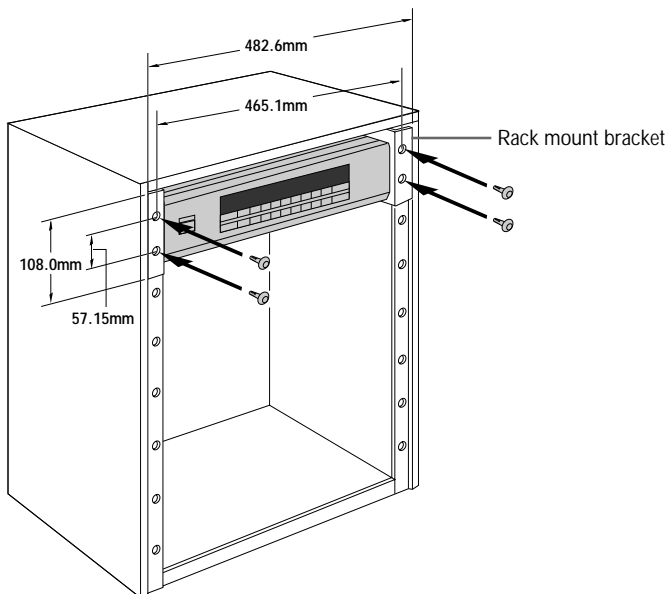

SPECIFICATIONS

Jacks		Rated Values
VIDEO 1 through 5	BNC input	Input impedance: 75Ω 1.0 Vp-p
	S input	Y: Input impedance: 75Ω 1.0 Vp-p
		C: Input impedance: 75Ω 0.28 Vp-p (Burst level)
Audio input L and R channels	Input impedance: 22 kΩ or greater 0.5 Vrms	
MONITOR OUT	BNC output	Output impedance: 75Ω 1.0 ±0.1 Vp-p (with 75Ω termination)
	S output	Y: Output impedance: 75Ω 1.0 ±0.1 Vp-p (with 75Ω termination)
		C: Output impedance: 75Ω 0.28 ±0.1 Vp-p (Burst level) (with 75Ω termination)
Audio output L and R channels	Output impedance: 1 kΩ or less 0.5 ±0.1 Vrms (with ATT 0 dB)	
RGB Input	BNC Input	R,G, B, H and V : Through out
	Audio input L and R channels	Input impedance 22 kΩ or greater 0.5 Vrms
RGB Output	BNC Output *	R,G, and B: Output impedance of 75Ω 0.7 ±0.1 Vp-p Note that the maximum deviation between R, G, and B is 0.05 V NOTE: From the blanking level to white peak (with 75Ω termination)
		HORIZONTAL and VERTICAL: High impedance 3.5 Vp-p (2.7 to 5.25 V)
		H/V: Output impedance of 75Ω 1.0 ±0.3 Vp-p
Audio output L and R channels	High impedance 0.5 ±0.1 Vrms (with ATT 0 dB)	
EXT CONTROL	D-SUB 15 (mini) connector	TTL level
PC CONTROL	D-SUB 15 (mini) connector	TTL level

When a phono pin plug is not connected to the right channel audio input (output) jack, the left channel audio input (output) jack functions as a monaural audio input (output) jack.

* When a signal is input via the RGB (THROUGH) connector, the signal is looped-through out.

Resolution: 500 lines horizontal
450 lines vertical

Noise reduction: Approx. 4 dB in NR mode 1
Approx. 8 dB in NR mode 2

Power supply: 120 V AC, 60 Hz

Input current: 0.6 A

Dimensions: 43.0 W × 12.0 H × 34.9 D (cm)
16 ³⁰/₃₂ W × 4 ²³/₃₂ H × 13 ²⁵/₃₂ D (inch)

Weight: 6.1 kg / 13.45 lbs

Supplied accessories: Remote control RD-338E, two AA size batteries, power cord, rack mount brackets (L and R), Coaxial cable (RGB H/V 5 conductor BNC/BNC)

- These specifications and contents are subject to change without notice.
- Dimension indications of the scan converter unit do not include protrusions such as knobs and handles.

APPENDIX (IDC-3000 stand alone PC-CONTROL command reference)

You can control the main functions from external equipment such as personal computer using the PC-CONTROL terminal. The following sections explain the interface.

Interface Condition

- RS-232C or RS-422
- Baud rate 9600 bps
- Data length 8 bits
- Parity Odd parity
- Stop bit 1 bit
- Communications mode Full duplex

Control Data Format

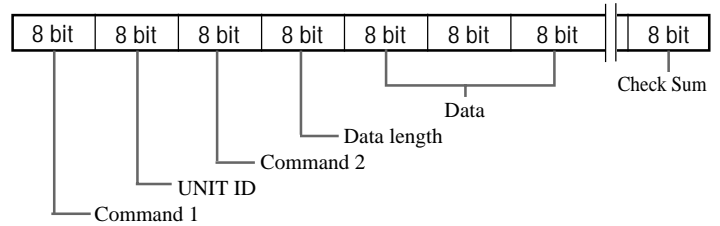

- Command 1 Code based on the command system
- UNIT ID Code allocated to each equipment
(Allocate 20H to the IDC-3000)
- Command 2 Code allocated to the main functions of the IDC-3000
- Data Length Number of bytes of the data that is transmitted
- Data Data that is transmitted
- Check Sum Lower eight digits of sum total of the first byte to the byte just before the last

Command Communication Sequence

When external equipment such as a personal computer gives the command to the IDC-3000, the IDC-3000 returns an ACK or NAK. So make sure that the external equipment receives this ACK or NAK.

Command sending/receiving sequence

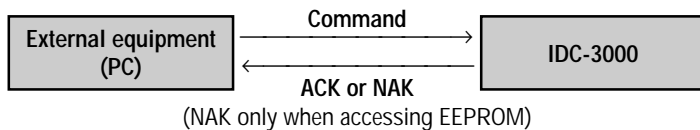

The IDC-3000 returns an ACK if it has received the command correctly. If it has not received the command correctly due to data error, it will return nothing. Therefore, when the external equipment send a command, make sure that it received the ACK.

The IDC-3000 returns a NAK only when a WRITE error has occurred during EEPROM access commands.

PC CONTROL COMMAND LIST FOR USE WITH THE IDC-3000

PC → IDC-3000

COM1	COM2	Contents	Length
9F	4E	Power On	00
	4F	Power Off	00
DF	47	Input switching	01

IDC-3000 → PC

COM1	COM2	Contents	Length
3F	4E	Power On (ACK)	00
	4F	Power Off (ACK)	00
	47	Input switching (ACK)	00

Example: Input switching (VIDEO 1) from the PC to the IDC-3000
(when the address selector equals 0)

PC → IDC-3000

COM1	UA	COM2	Leng	Data	Sum
DF	20	47	01	01	48

— VIDEO 2 : 02
 — VIDEO 3 : 03
 — VIDEO 4 : 04
 — VIDEO 5 : 05
 — RGB : 06

IDC-3000 → PC

COM1	UA	COM2	Leng	Sum
3F	20	47	00	A6

PROFESSIONAL GRAPHICS PRODUCTS LIMITED WARRANTY

NEC Technologies, Inc. (hereafter NECTECH) warrants this product to be free from defects in material and workmanship under the following terms.

HOW LONG IS THE WARRANTY

Parts and labor are warranted for (1) One Year from the date of the first customer purchase.

WHO IS PROTECTED

This warranty may be enforced only by the first purchaser.

WHAT IS COVERED AND WHAT IS NOT COVERED

Except as specified below, this warranty covers all defects in material or workmanship in this product. The following are not covered by the warranty:

1. Any product which is not distributed in the U.S.A., Canada, and Mexico by NECTECH or which is not purchased in the U.S.A., Canada, and Mexico from an authorized NECTECH dealer.
Authorized NECTECH dealers can be identified by an NEC window decal. Any dealer which does not display this decal may be an unauthorized dealer. If you are uncertain as to whether a dealer is authorized, please contact NECTECH at (708)-238-7764.

HOW YOU CAN GET WARRANTY SERVICE

1. To obtain service on your product, consult the dealer from whom you purchased the product, or ship it prepaid to any authorized NECTECH service center.
2. Whenever warranty service is required, the original dated invoice (or a copy) must be presented as proof of warranty coverage, and should be included in any shipment of the product.
Please also include in any mailing, your name, address and a description of the problem(s).
3. For the name of the nearest NECTECH authorized service center, contact your dealer or NECTECH.

LIMITATION OF IMPLIED WARRANTIES

All implied warranties, including warranties of merchantability and fitness for a particular purpose, are limited in duration to the length of this warranty.

EXCLUSION OF DAMAGES

NECTECH'S liability for any defective product is limited to the repair or replacement of the product at our option. NECTECH shall not be liable for:

1. Damage to other property caused by any defects in this product, damages based upon inconvenience, loss of use of the product, loss of time, commercial loss; or
2. Any other damages whether incidental, consequential or otherwise.
Some states do not allow limitation on how long an implied warranty lasts and/or do not allow the exclusion or limitation of incidental or

2. Any product on which the serial number has been defaced, modified or removed.
3. Damage, deterioration or malfunction resulting from:
 - a. Accident, misuse, abuse, neglect, fire, water, lightning or other acts of nature, unauthorized product modification, or failure to follow instructions supplied with the products.
 - b. Repair or attempted repair by anyone not authorized by NECTECH.
 - c. Any shipment of the product (claims must be presented to the carrier)
 - d. Removal or installation of the product.
 - e. Any other cause which does not relate to a product defect.
 - f. Burns or residual images upon the phosphor of the tubes.
4. Cartons, carry cases, batteries, external cabinets, magnetic tapes, or any accessories used in connection with the product.

WHAT WE WILL PAY FOR AND WHAT WE WILL NOT PAY FOR

We will pay labor and material expenses for covered items, but we will not pay for the following:

1. Removal or installation charges.
2. Costs of initial technical adjustments (set-up), including adjustment of user controls. These costs are the responsibility of the NECTECH dealer for whom the product was purchased.
3. Payment of shipping charges.

consequential damages, so the above limitations and exclusions may not apply to you.

HOW STATE LAW RELATES TO THE WARRANTY

This warranty gives you specific legal rights, and you may also have other rights which vary from state to state.

FOR ALL INFORMATION, TELEPHONE: 708-238-7764
NEC Technologies, Inc., 1255 Michael Drive
Wood Dale, IL 60191

• MEMO •